

KEITHLEY

4200-SCS Semiconductor Characterization System

QuickStart Manual

A GREATER MEASURE OF CONFIDENCE

4200-SCS
Semiconductor Characterization System
QuickStart Manual

©2000, Keithley Instruments, Inc.
All rights reserved.
Cleveland, Ohio, U.S.A.
First Printing, November 2003
Document Number: 4200-903-01 Rev. A

Model 4200-SCS

License Agreement

NOTICE TO USERS: CAREFULLY READ THE FOLLOWING LICENSE AGREEMENT (THE "AGREEMENT"). USE OF THE SOFTWARE (THE "SOFTWARE") PROVIDED WITH THE 4200-SEMICONDUCTOR CHARACTERIZATION SYSTEM (THE "4200-SCS") CONSTITUTES YOUR ACCEPTANCE OF THESE TERMS. IF YOU DO NOT AGREE WITH THE TERMS OF THIS AGREEMENT, PROMPTLY RETURN THE SOFTWARE AND THE ACCOMPANYING ITEMS, INCLUDING ANY WRITTEN MATERIALS AND PACKAGING, TO THE LOCATION WHERE YOU OBTAINED THEM FOR A FULL REFUND.

Grant of License

Keithley Instruments ("Keithley") grants to you, subject to the terms and conditions of this Agreement, a non-exclusive, non-transferable license to use the portion of the Software developed and owned by Keithley (the "Keithley Software") on the 4200-SCS and to use the manuals and other related materials pertaining to the Software which are necessary or desirable for the implementation, training or use of the Software (the "Documentation") for your own internal business use and not for the benefit of any other person or entity. You may copy the Keithley Software into any machine-readable or printed form only for backup purposes or as necessary to use the Keithley Software or the 4200-SCS in accordance with this Agreement. The Keithley Software and Documentation and any copies or modifications thereof are referred to herein as the "Licensed Product."

Ownership

Keithley and certain third party suppliers (the "Owners") own all right, title and interest in and to the Licensed Product. You acknowledge that all right, title and interest in and to the Licensed Product will remain the exclusive property of the Owners, and you will not acquire any rights in or to the Licensed Product except as expressly set forth in this Agreement. The Licensed Product contains material that is protected by U.S. copyright laws, trade secret laws and international treaty provisions.

Limitations on Use

You may not make the Software available over the Internet or any similar networking technology. You may not remove any copyright, trademark or other proprietary notices from the Licensed Product or any media relating thereto. You agree that you will not attempt to reverse compile, reverse engineer, modify, translate, adapt or disassemble the Software, nor attempt to create the source code from the object code for the Software, in whole or in part.

Sublicense

You may sublicense the Keithley Software, subject to the sublicensee's acceptance of the terms and conditions of this Agreement. You may not rent, lease or otherwise transfer the Licensed Product.

Termination

This Agreement is effective until terminated. Either party shall have the right to terminate this Agreement if the other fails to perform or observe any provision, term, covenant, warranty or condition of this Agreement (a "Default") provided fifteen (15) days notice of termination (the "Notice") is provided to the defaulting party and the defaulting party fails to cure the claimed Default within ten (10) days from the date of receipt of the Notice. Within three (3) days from the date of any termination of this Agreement, each and every embodiment of the Software in any form whatsoever, and all documentation, files and other materials in any form relating thereto, shall be destroyed, and all traces of the Software shall be permanently purged from the 4200-SCS.

Export Restrictions

You may not export or re-export the Software or any copy or adaptation in violation of any applicable laws or regulations.

U.S. Government Restricted Rights

Use, duplication and disclosure by the U.S. Government is subject to the restrictions as set forth in FAR §52.227-14 Alternates I, II and III (JUN 1987), FAR §52.227-19 (JUN 1987), and/or FAR §12.211/12.212 (Commercial Technical Data/Computer Software), and DFARS §252.227-7015 (NOV 1995) (Technical Data) and/or DFARS §227.7202 (Computer Software), as applicable.

Limited Warranty

Keithley does not warrant that operation of the Software will be uninterrupted or error-free or that the Software will be adequate for the customer's intended application or use. Keithley warrants to you that the Keithley Software will substantially perform in accordance with the specifications set forth in this manual for a period of ninety (90) days after your receipt of the Keithley Software (the "Warranty Period"); provided the Keithley Software is used on the products for which it is intended and in accordance with the Documentation. If the Keithley Software is not performing as warranted during the Warranty Period, as determined by Keithley in its sole discretion (a "Nonconformity"), your exclusive remedy under this limited warranty is either a correction of the Keithley Software or an explanation by Keithley of how to use the Keithley Software despite the Nonconformity, at Keithley's option. The foregoing limited warranty shall be null and void upon any modification of the Software, unless approved in writing by Keithley. The portions of the Software not developed and owned by Keithley shall not be covered by this limited warranty, and Keithley shall have no duty or obligation to enforce any third party supplier's warranties on your behalf. The failure to notify Keithley of a Nonconformity during the Warranty Period shall relieve Keithley of its obligations and liabilities under this limited warranty.

EXCEPT FOR THE FOREGOING, THE SOFTWARE IS PROVIDED "AS IS" WITHOUT ANY WARRANTY OF ANY KIND, INCLUDING BUT NOT LIMITED TO, THE WARRANTIES OF MERCHANTABILITY AND FITNESS FOR A PARTICULAR PURPOSE.

THE SOFTWARE IS NOT FAULT TOLERANT AND IS NOT DESIGNED OR INTENDED FOR USE IN HAZARDOUS ENVIRONMENTS REQUIRING FAIL-SAFE PERFORMANCE INCLUDING WITHOUT LIMITATION, IN THE OPERATION OF NUCLEAR FACILITIES, AIRCRAFT NAVIGATION OR COMMUNICATION SYSTEMS, AIR TRAFFIC CONTROL, WEAPONS SYSTEMS, DIRECT LIFE-SUP-

PORT MACHINES, OR ANY OTHER APPLICATION IN WHICH THE FAILURE OF THE SOFTWARE COULD LEAD TO DEATH, PERSONAL INJURY OR SEVERE PHYSICAL OR PROPERTY DAMAGE (COLLECTIVELY "HAZARDOUS ACTIVITIES"). KEITHLEY EXPRESSLY DISCLAIMS ANY EXPRESS OR IMPLIED WARRANTY OF FITNESS FOR HAZARDOUS ACTIVITIES.

Limitation of Liability

KEITHLEY'S SOLE LIABILITY OR OBLIGATION UNDER THIS AGREEMENT IS SET FORTH ABOVE IN THE LIMITED WARRANTY SECTION OF THIS AGREEMENT. IN NO EVENT SHALL KEITHLEY BE LIABLE FOR ANY DAMAGES. WITHOUT LIMITING THE FOREGOING, KEITHLEY SHALL NOT BE LIABLE OR ASSUME LIABILITY FOR: (1) ECONOMICAL, INCIDENTAL, CONSEQUENTIAL, INDIRECT, SPECIAL, PUNITIVE OR EXEMPLARY DAMAGES, WHETHER CLAIMED UNDER CONTRACT, TORT OR ANY OTHER LEGAL THEORY, (2) LOSS OF OR DAMAGE TO YOUR DATA OR PROGRAMMING, (3) PENALTIES OR PENALTY CLAUSES OF ANY DESCRIPTION, OR (4) INDEMNIFICATION OF YOU OR OTHERS FOR COSTS, DAMAGES, OR EXPENSES RELATED TO THE GOODS OR SERVICES PROVIDED UNDER THIS LIMITED WARRANTY.

Miscellaneous

In the event of invalidity of any provision of this Agreement, the parties agree that such invalidity shall not affect the validity of the remaining portions of this Agreement. This Agreement shall be governed by and construed in accordance with the laws of the state of Ohio, without regard to conflicts of laws provisions thereof. This is the entire agreement between you and Keithley and supersedes any prior agreement or understanding, whether written or oral, relating to the subject matter of this license. Any waiver by either party of any provision of this Agreement shall not constitute or be deemed a subsequent waiver of that or any other provision.

Should you have any questions concerning this Agreement, or if you desire to contact Keithley Instruments for any reason, please call Keithley at 1-800-552-1115, or write at Keithley Instruments, 28775 Aurora Rd., Solon, Ohio, USA 44139.

Limited Hardware Warranty

Keithley warrants to you that the Keithley manufactured portion of the hardware (the "Keithley Hardware") purchased by you will substantially perform in accordance with the specifications set forth in this manual for a period of one (1) year after your receipt of the Keithley Hardware (the "Warranty Period"); provided the Keithley Hardware is used on the products for which it is intended and in accordance with the documentation. This limited warranty shall be null and void upon (1) any modifications of the Keithley Hardware, unless approved in writing by Keithley, (2) any operation of the 4200-Semiconductor Characterization System (the "4200-SCS") with third party software, unless the software is explicitly approved and supported by Keithley, and (3) any operation of the 4200-SCS on an operating system not explicitly approved and supported by Keithley.

If the Keithley Hardware is not performing as warranted during the Warranty Period, as determined in Keithley's sole discretion (a "Nonconformity"), your exclusive remedy under this limited warranty is the repair or replacement of the Keithley Hardware, at Keithley's option. The portions of the hardware not developed and owned by Keithley shall not be covered by this limited hardware warranty, and Keithley shall have no duty or obligation to enforce a third party supplier's warranties on your behalf. The failure to notify Keithley of a Nonconformity during the Warranty Period shall relieve Keithley of its obligations and liabilities under this limited hardware warranty.

EXCEPT FOR THE FOREGOING, THE HARDWARE IS PROVIDED "AS IS" WITHOUT ANY WARRANTY OF ANY KIND, INCLUDING BUT NOT LIMITED TO, THE WARRANTIES OF MERCHANTABILITY AND FITNESS FOR A PARTICULAR PURPOSE.

KEITHLEY'S SOLE LIABILITY OR OBLIGATION UNDER THIS LIMITED HARDWARE WARRANTY IS THE REPAIR OR REPLACEMENT OF THE KEITHLEY HARDWARE. IN NO EVENT SHALL KEITHLEY BE LIABLE FOR ANY DAMAGES. WITHOUT LIMITING THE FOREGOING, KEITHLEY SHALL NOT BE LIABLE OR ASSUME LIABILITY FOR: (1) ECONOMICAL, INCIDENTAL, CONSEQUENTIAL, INDIRECT, SPECIAL, PUNITIVE OR EXEMPLARY DAMAGES, WHETHER CLAIMED UNDER CONTRACT, TORT OR ANY OTHER LEGAL THEORY, (2) LOSS OF OR DAMAGE TO YOUR DATA OR PROGRAMMING, (3) PENALTIES OR PENALTY CLAUSES OF ANY DESCRIPTION, OR (4) INDEMNIFICATION OF YOU OR OTHERS FOR COSTS, DAMAGES OR EXPENSES RELATED TO THE GOODS OR SERVICES PROVIDED UNDER THIS LIMITED HARDWARE WARRANTY.

Should you have any questions concerning this Agreement, or if you desire to contact Keithley Instruments for any reason, please call 1-800-552-1115, or write at Keithley Instruments, 28775 Aurora Rd., Solon, Ohio, USA 44139.



A GREATER MEASURE OF CONFIDENCE

Keithley Instruments, Inc.

Corporate Headquarters • 28775 Aurora Road • Cleveland, Ohio 44139 • 440-248-0400 • Fax: 440-248-6168 • 1-888-KEITHLEY (534-8453) • www.keithley.com

Belgium: Sint-Pieters-Leeuw • 02-363 00 40 • Fax: 02-363 00 64 • www.keithley.nl

China: Beijing • 8610-82251886 • Fax: 8610-82251892 • www.keithley.com.cn

Finland: Helsinki • 09-5306-6560 • Fax: 09-5306-6565 • www.keithley.com

France: Palaiseau C dex • 01-64 53 20 20 • Fax: 01-60 11 77 26 • www.keithley.fr

Germany: Germering • 089/84 93 07-40 • Fax: 089/84 93 07-34 • www.keithley.de

Great Britain: Theale • 0118 929 7500 • Fax: 0118 929 7519 • www.keithley.co.uk

India: Bangalore • 080 212 8027 • Fax: 080 212 8005 • www.keithley.com

Italy: Milano • 02-48 39 16 01 • Fax: 02-48 30 22 74 • www.keithley.it

Japan: Tokyo • 81-3-5733-7555 • Fax: 81-3-5733-7556 • www.keithley.jp

Korea: Seoul • 82-2-574-7778 • Fax: 82-2-574-7838 • www.keithley.com

Netherlands: Gorinchem • 0183-635333 • Fax: 0183-630821 • www.keithley.nl

Singapore: Singapore • 65-6747-9077 • Fax: 65-6747-2991 • www.keithley.com

Sweden: Solna • 08-509 04 600 • Fax: 08-655 26 10 • www.keithley.com

Taiwan: Hsinchu • 886-3-572-9077 • Fax: 886-3-572-9031 • www.keithley.com.tw

Manual Print History

The print history shown below lists the printing dates of all Revisions and Addenda created for this manual. The Revision Level letter increases alphabetically as the manual undergoes subsequent updates. Addenda, which are released between Revisions, contain important change information that the user should incorporate immediately into the manual. Addenda are numbered sequentially. When a new Revision is created, all Addenda associated with the previous Revision of the manual are incorporated into the new Revision of the manual. Each new Revision includes a revised copy of this print history page.

Revision A (Document Number 4200-903-01) November 2003

The following safety precautions should be observed before using this product and any associated instrumentation. Although some instruments and accessories would normally be used with non-hazardous voltages, there are situations where hazardous conditions may be present.

This product is intended for use by qualified personnel who recognize shock hazards and are familiar with the safety precautions required to avoid possible injury. Read and follow all installation, operation, and maintenance information carefully before using the product. Refer to the manual for complete product specifications.

If the product is used in a manner not specified, the protection provided by the product may be impaired.

The types of product users are:

Responsible body is the individual or group responsible for the use and maintenance of equipment, for ensuring that the equipment is operated within its specifications and operating limits, and for ensuring that operators are adequately trained.

Operators use the product for its intended function. They must be trained in electrical safety procedures and proper use of the instrument. They must be protected from electric shock and contact with hazardous live circuits.

Maintenance personnel perform routine procedures on the product to keep it operating properly, for example, setting the line voltage or replacing consumable materials. Maintenance procedures are described in the manual. The procedures explicitly state if the operator may perform them. Otherwise, they should be performed only by service personnel.

Service personnel are trained to work on live circuits, and perform safe installations and repairs of products. Only properly trained service personnel may perform installation and service procedures.

Keithley products are designed for use with electrical signals that are rated Measurement Category I and Measurement Category II, as described in the International Electrotechnical Commission (IEC) Standard IEC 60664. Most measurement, control, and data I/O signals are Measurement Category I and must not be directly connected to mains voltage or to voltage sources with high transient over-voltages. Measurement Category II connections require protection for high transient over-voltages often associated with local AC mains connections. Assume all measurement, control, and data I/O connections are for connection to Category I sources unless otherwise marked or described in the Manual.

Exercise extreme caution when a shock hazard is present. Lethal voltage may be present on cable connector jacks or test fixtures. The American National Standards Institute (ANSI) states that a shock hazard exists when voltage levels greater than 30V RMS, 42.4V peak, or 60VDC are present. **A good safety practice is to expect that hazardous voltage is present in any unknown circuit before measuring.**

Operators of this product must be protected from electric shock at all times. The responsible body must ensure that operators are prevented access and/or insulated from every connection point. In some cases, connections must be exposed to potential human contact. Product operators in these circumstances must be trained to protect themselves from the risk of electric shock. If the circuit is capable of operating at or above 1000 volts, **no conductive part of the circuit may be exposed.**

Do not connect switching cards directly to unlimited power circuits. They are intended to be used with impedance limited sources. NEVER connect switching cards directly to AC mains. When connecting sources to switching cards, install protective devices to limit fault current and voltage to the card.

Before operating an instrument, make sure the line cord is connected to a properly grounded power receptacle. Inspect the connecting cables, test leads, and jumpers for possible wear, cracks, or breaks before each use.

When installing equipment where access to the main power cord is restricted, such as rack mounting, a separate main input power disconnect device must be provided, in close proximity to the equipment and within easy reach of the operator.

For maximum safety, do not touch the product, test cables, or any other instruments while power is applied to the circuit under test. ALWAYS remove power from the entire test system and discharge any capacitors before: connecting or disconnecting cables or jumpers, installing or removing switching cards, or making internal changes, such as installing or removing jumpers.

Do not touch any object that could provide a current path to the common side of the circuit under test or power line (earth) ground. Always make measurements with dry hands while standing on a dry, insulated surface capable of withstanding the voltage being measured.


The instrument and accessories must be used in accordance with its specifications and operating instructions or the safety of the equipment may be impaired.


Do not exceed the maximum signal levels of the instruments and accessories, as defined in the specifications and operating information, and as shown on the instrument or test fixture panels, or switching card.


When fuses are used in a product, replace with same type and rating for continued protection against fire hazard.


Chassis connections must only be used as shield connections for measuring circuits, NOT as safety earth ground connections.

If you are using a test fixture, keep the lid closed while power is applied to the device under test. Safe operation requires the use of a lid interlock.

If a  screw is present, connect it to safety earth ground using the wire recommended in the user documentation.

The  symbol on an instrument indicates that the user should refer to the operating instructions located in the manual.

The  symbol on an instrument shows that it can source or measure 1000 volts or more, including the combined effect of normal and common mode voltages. Use standard safety precautions to avoid personal contact with these voltages.

The  symbol indicates a connection terminal to the equipment frame.

The **WARNING** heading in a manual explains dangers that might result in personal injury or death. Always read the associated information very carefully before performing the indicated procedure.

The **CAUTION** heading in a manual explains hazards that could damage the instrument. Such damage may invalidate the warranty.

Instrumentation and accessories shall not be connected to humans.

Before performing any maintenance, disconnect the line cord and all test cables.

To maintain protection from electric shock and fire, replacement components in mains circuits, including the power transformer, test leads, and input jacks, must be purchased from Keithley Instruments. Standard fuses, with applicable national safety approvals, may be used if the rating and type are the same. Other components that are not safety related may be purchased from other suppliers as long as they are equivalent to the original component. (Note that selected parts should be purchased only through Keithley Instruments to maintain accuracy and functionality of the product.) If you are unsure about the applicability of a replacement component, call a Keithley Instruments office for information.

To clean an instrument, use a damp cloth or mild, water based cleaner. Clean the exterior of the instrument only. Do not apply cleaner directly to the instrument or allow liquids to enter or spill on the instrument. Products that consist of a circuit board with no case or chassis (e.g., data acquisition board for installation into a computer) should never require cleaning if handled according to instructions. If the board becomes contaminated and operation is affected, the board should be returned to the factory for proper cleaning/servicing.

Model 4200-SCS Hardware Specifications

Specification Conditions

Specifications are the performance standards against which the 4200-SMU, 4210-SMU, and 4200-PA are tested. The measurement and source accuracy are specified at the termination of the supplied cables.

- 23°C ±5°C, within 1 year of calibration, RH between 5% and 60%, after 30 minutes of warm-up.
- Speed set to NORMAL.
- Guarded Kelvin connection.
- ±1°C and 24 hours from ACAL.

CURRENT SPECIFICATIONS

	CURRENT RANGE ¹	MAX. VOLTAGE	MEASURE		SOURCE	
			RESOLUTION ³	ACCURACY ±(% rdg + amps)	RESOLUTION ³	ACCURACY ±(% rdg + amps)
4210-SMU ² High Power SMU	1 A	21 V	1 µA	0.100 % + 200 µA	50 µA	0.100 % + 350 µA
	100 mA	210 V	100 nA	0.045 % + 3 µA	5 µA	0.050 % + 15 µA
4200-SMU ² Medium Power SMU	100 mA	21 V	100 nA	0.045 % + 3 µA	5 µA	0.050 % + 15 µA
	10 mA	210 V	10 nA	0.037 % + 300 nA	500 nA	0.042 % + 1.5 µA
	1 mA	210 V	1 nA	0.035 % + 30 nA	50 nA	0.040 % + 150 nA
	100 µA	210 V	100 pA	0.033 % + 3 nA	5 nA	0.038 % + 15 nA
	10 µA	210 V	10 pA	0.050 % + 600 pA	500 pA	0.060 % + 1.5 nA
	1 µA	210 V	1 pA	0.050 % + 100 pA	50 pA	0.060 % + 200 pA
	100 nA	210 V	100 fA	0.050 % + 30 pA	5 pA	0.060 % + 30 pA
	10 nA	210 V	10 fA	0.050 % + 1 pA	500 fA	0.060 % + 3 pA
4200-SMU and 4210-SMU with optional 4200-PA PreAmp	1 nA	210 V	3 fA	0.050 % + 100 fA	50 fA	0.060 % + 300 fA
	100 pA	210 V	1 fA	0.100 % + 30 fA	15 fA	0.100 % + 80 fA
	10 pA	210 V	0.3 fA	0.500 % + 15 fA	5 fA	0.500 % + 50 fA
	1 pA	210 V	100 aA	1.000 % + 10 fA	1.5 fA	1.000 % + 40 fA

VOLTAGE COMPLIANCE: Bipolar limits set with a single value between full scale and 10% of selected voltage range.

VOLTAGE SPECIFICATIONS

VOLTAGE RANGE ¹	MAX. CURRENT		MEASURE		SOURCE	
	4200-SMU	4210-SMU	RESOLUTION ³	ACCURACY ±(% rdg + volts)	RESOLUTION ³	ACCURACY ±(% rdg + volts)
200 V ⁴	10.5 mA	105 mA	200 µV	0.015 % + 3 mV	5 mV	0.02% + 15 mV
20 V	105 mA	1.05 A	20 µV	0.01 % + 1 mV	500 µV	0.02% + 1.5 mV
2 V	105 mA	1.05 A	2 µV	0.012 % + 150 µV	50 µV	0.02% + 300 µV
200 mV	105 mA	1.05 A	1 µV	0.012 % + 100 µV	5 µV	0.02% + 150 µV

CURRENT COMPLIANCE: Bipolar limits set with a single value between full scale and 10% of selected current range.

SUPPLEMENTAL INFORMATION

Supplemental information is not warranted, but provides useful information about the 4200-SMU, 4210-SMU, and 4200-PA.

COMPLIANCE ACCURACY:

- Voltage compliance equals the voltage source specifications.
- Current compliance equals the current source specifications.

OVERSHOOT: <0.1% typical.

- Voltage: Full scale step, resistive load, and 10mA range.
- Current: 1mA step, R_L = 10kΩ, 20V range.

RANGE CHANGE TRANSIENT:

- Voltage Ranging: <200mV.
- Current Ranging: <200mV.

ACCURACY SPECIFICATIONS: Accuracy specifications are multiplied by one of the following factors, depending upon the ambient temperature and humidity.

TEMPERATURE	% RELATIVE HUMIDITY	
	5-60	60-80
10°-18°C	∞3	∞3
18°-28°C	∞1	∞3
28°-40°C	∞3	∞5

REMOTE SENSE:

- <10Ω in series with FORCE terminal not to exceed a 5V difference between FORCE and SENSE terminals.
- ±30V maximum between COMMON and SENSE LO.

MAXIMUM LOAD CAPACITANCE: 10nF

MAXIMUM GUARD OFFSET VOLTAGE: 3mV from FORCE.

GUARD OUTPUT IMPEDANCE: 100kΩ.

MAXIMUM GUARD CAPACITANCE: 1500pF

MAXIMUM SHIELD CAPACITANCE: 3300pF

4200-SMU and 4210-SMU SHUNT RESISTANCE (FORCE to COMMON): >10¹²Ω (100nA-1µA ranges).

4200-PA SHUNT RESISTANCE (FORCE to COMMON): >10¹⁶Ω (1pA and 10pA ranges), >10¹³Ω (100pA-100nA ranges).

OUTPUT TERMINAL CONNECTION: Dual triaxial connectors for 4200-PA, dual mini-triaxial connectors for 4200-SMU and 4210-SMU.

NOISE CHARACTERISTICS (typical):

- Voltage Source (rms): 0.01% of output range.
- Current Source (rms): 0.1% of output range.
- Voltage Measure (p-p): 0.02% of measurement range.
- Current Measure (p-p): 0.2% of measurement range.

MAXIMUM SLEW RATE: 0.2V/µs.

ADDITIONAL SPECIFICATIONS

MAX. OUTPUT POWER: 22 watts for 4210-SMU and 2.2 watts for 4200-SMU (both are four-quadrant source/sink operation).

DC FLOATING VOLTAGE: COMMON can be floated ± 32 volts from chassis ground.

VOLTAGE MONITOR (SMU in VMU mode):

VOLTAGE RANGE	MEASURE RESOLUTION	MEASURE ACCURACY $\pm(\%rdg + volts)$
200 V	200 μ V	0.015% + 3 mV
20 V	20 μ V	0.01% + 1 mV
2 V	2 μ V	0.012% + 110 μ V
200 mV	1 μ V	0.012% + 80 μ V

INPUT IMPEDANCE: $>10^{13}\Omega$.

INPUT LEAKAGE CURRENT: <30 pA.

MEASUREMENT NOISE: 0.02% of measurement range (rms).

DIFFERENTIAL VOLTAGE MONITOR:

Differential Voltage Monitor is available by measuring with two SMUs in VMU mode, or by using the low sense terminal provided with each SMU.

GROUND UNIT

Voltage error when using the ground unit is included in the 4200-SMU, 4210-SMU, and 4200-PA specifications. No additional errors are introduced when using the ground unit.

OUTPUT TERMINAL CONNECTION: Dual triaxial, 5-way binding post.

MAXIMUM CURRENT: 2.6A using dual triaxial connection; 4.4A using 5-way binding posts.

LOAD CAPACITANCE: No limit.

CABLE RESISTANCE: FORCE $\leq 1\Omega$, SENSE $\leq 10\Omega$.

GENERAL

TEMPERATURE RANGE

Operating: $+10^{\circ}$ to $+40^{\circ}$ C.

Storage: -15° to $+60^{\circ}$ C.

HUMIDITY RANGE

Operating: 5% to 80% RH, non-condensing.

Storage: 5% to 90% RH, non-condensing.

ALTITUDE

Operating: 0 to 2000m.

Storage: 0 to 4600m.

POWER REQUIREMENTS: 100V to 240V, 50 to 60Hz.

MAXIMUM VA: 500VA.

REGULATORY COMPLIANCE:

Safety: Low Voltage Directive 73/23/EEC.

EMC: Directive 89/336/EEC.

DIMENSIONS: 43.6cm wide ∞ 22.3cm high ∞ 56.5cm deep (17 $\frac{1}{2}$ in ∞ 8 $\frac{3}{4}$ in ∞ 22 $\frac{1}{4}$ in).

WEIGHT (approx.): 29.7kg (65.5 lbs) for typical configuration of four SMUs.

I/O PORTS: SVGA, Printer, RS-232, GPIB, Ethernet, Mouse, Keyboard.

ACCESSORIES SUPPLIED:

4200-MTRX-2 Ultra Low Noise SMU Triax Cable (2 supplied for each SMU), 2m (6.6 ft). Not included with SMUs configured with a 4200-PA PreAmp.

4200-TRX-2 Ultra Low Noise PreAmp Triax Cables, 2m (6.6 ft). 2 supplied for Ground Unit. 2 supplied in replacement of 4200-MTRX-2 cables for each SMU configured with a 4200-PA.

4200-RPC-2 Remote PreAmp Cable (1 supplied for each PreAmp), 2m (6.6 ft).

236-ILC-3 Interlock Cable, 3m (10 ft)

Line Cord NEMA 5-15P for 100–115VAC.
CEE 7/7 (Continental European) for 240VAC.

Keyboard and Pointing Device
User Manual

NOTES

¹ All ranges extend to 105% of full scale.

² Specifications apply on these ranges with or without a 4200-PA.

³ Specified resolution is limited by fundamental noise limits. Measured resolution is 6 $\frac{1}{2}$ digits on each range. Source resolution is 4 $\frac{1}{2}$ digits on each range.

⁴ Interlock must be engaged to use the 200V range.

Specifications are subject to change without notice.

Table of Contents

1 Understanding and Preparing the System

Unpacking and inspecting the system	1-2
Becoming familiar with the system	1-2
Software features	1-3
Hardware features and capabilities	1-4
Locating the system in the proper environment	1-8
Connecting system components	1-9
Connecting devices to be tested (DUTs)	1-10
Basic device connections	1-10
Device-connection details	1-11
Powering the 4200-SCS	1-12
Configuring the system	1-13

2 Designing and Executing Tests

Understanding the 4200-SCS test hierarchy and terminology	2-2
Becoming familiar with the KITE interface	2-2
Understanding the Project Navigator	2-4
Understanding Interactive Test Modules (ITMs) and User Test Modules (UTMs)	2-5
Building a Project	2-6
Define the new Project	2-6
Insert the Subsite Plans	2-7
Insert the Device Plans	2-8
Insert the ITMs	2-8
Insert the UTMs	2-10
Save the Project	2-11
Defining and configuring the Project ITMs	2-11
Understand the ITM Definition tab	2-11
Understand the ITM forcing functions	2-13
Use the Definition tab to configure ITM parameters	2-14
Set up Formulator calculations, if desired	2-16
Save the ITM configuration	2-16
Defining and configuring the Project UTMs	2-17
Understand the UTM Definition tab	2-17
Define UTMs using the UTM Definition tab	2-18
Create custom user modules and user libraries, if necessary	2-19

Executing the Project tests	2-25
Executing a single test at a single site	2-25
_RevA\QSBook\Art\Sec02	2-26
Executing appended tests and test sequences at a single site	2-27
Executing an entire Project at a single site	2-27
Executing an entire Project at multiple sites	2-28
Repeating a test	2-30
Subsite cycling overview	2-30

3 Viewing test results

Understanding the data files	3-2
Data file naming	3-2
Data file location	3-2
Viewing test results numerically via the Sheet tab Data worksheet	3-3
Viewing test results graphically via the Graph tab	3-4
Opening a Graph tab	3-4
Reviewing the Graph Setting menu	3-5
Defining a basic graph	3-7

4 Protecting user files and system software

Protecting software integrity	4-2
Protecting user file integrity	4-2
Choosing the files to be backed up	4-2
Choosing the method of backup	4-3

List of Illustrations

1 Understanding and Preparing the System

Figure 1-1	4200-SCS summary	1-3
Figure 1-2	Front panel	1-4
Figure 1-3	Source-measure hardware overview	1-5
Figure 1-4	Signal types and absolute limits at source-measure hardware connectors	1-6
Figure 1-5	Source-measure operating boundaries	1-7
Figure 1-6	Triax cables for the 4200-SCS	1-7
Figure 1-7	Back panel view, system connectors, and system connections	1-9
Figure 1-8	Back panel and basic device connections to SMUs and Preamps	1-10
Figure 1-9	Line power receptacle	1-12
Figure 1-10	KCON overview	1-14

2 Designing and Executing Tests

Figure 2-1	KITE interface overview	2-3
Figure 2-2	Project Navigator	2-4
Figure 2-3	ITMs and UTM's in the Project Navigator	2-5
Figure 2-4	Define New Project window	2-6
Figure 2-5	Define New Project window configured for the u_build Project Plan	2-7
Figure 2-6	Selecting a new device plan from the 4200-SCS device library	2-8
Figure 2-7	Device Plan Window	2-9
Figure 2-8	Selecting an ITM from the 4200-SCS device library	2-9
Figure 2-9	Adding an ITM to the Test Sequence Table	2-10
Figure 2-10	ITM Definition tab — and neighboring tabs	2-12
Figure 2-11	Typical Forcing Functions/Measure Options window for an existing library ITM	2-15
Figure 2-12	UTM-creation overview	2-17
Figure 2-13	UTM Definition tab	2-18
Figure 2-14	Blank UTM Definition tab	2-18
Figure 2-15	Example of configured UTM tab	2-19
Figure 2-16	KULT interface overview	2-20
Figure 2-17	Site Navigator for Example Project	2-25
Figure 2-18	Site Navigator for example Project	2-26
Figure 2-19	Setting the site number in the Project window.	2-27
Figure 2-20	Multi-site test sequence	2-28
Figure 2-21	Setting the site numbers in the Project window	2-29
Figure 2-22	Repeating a test	2-30
Figure 2-23	Cycle mode configuration	2-31
Figure 2-24	Start subsite cycling	2-31
Figure 2-25	Stress/Measure Mode – log cycle times setup	2-32
Figure 2-26	Device Stress Properties – Setup steps for first device in Subsite Plan	2-33

Figure 2-27	Exporting ITM Output Values to the Subsite Data sheet	2-34
Figure 2-28	Example Subsite Data sheet for the Stress/Measure Mode	2-35
Figure 2-29	Example Subsite Graph for the Stress/Measure Mode	2-35

3 Viewing test results

Figure 3-1	Workspace-window tab name and data file name format	3-2
Figure 3-2	.Sheet tab Data worksheet	3-3
Figure 3-3	Graph tab example	3-4
Figure 3-4	Example of an unconfigured graph tab	3-5
Figure 3-5	Graph settings menu	3-5
Figure 3-6	Unconfigured Graph Definition window for a “vds-id” ITM	3-7
Figure 3-7	Configured Graph Definition window for the “vds-id” ITM	3-8
Figure 3-8	“vds-id” graph after configuring its Graph Definition window	3-8

List of Tables

1	Understanding and Preparing the System	
Table 1-1	Additional device connection diagrams in Section 4 of the Reference Manual	1-11
2	Designing and Executing Tests	
Table 2-1	Primary differences between an ITM and a UTM	2-6
Table 2-2	Forcing function summary	2-13
4	Protecting user files and system software	
Table 4-1	Common backup storage options for the 4200-SCS	4-3

1

Understanding and Preparing the System

Unpacking and inspecting the system

Inspection for damage

After unpacking the mainframe, carefully inspect the unit for any shipping damage. Report any damage to the shipping agent immediately as such damage is not covered by the warranty.

Shipment contents

The following items are included with every Model 4200-SCS order:

- Model 4200-SCS Semiconductor Characterization System with ordered SMUs factory installed
- Ordered Model 4200-PA modules factory installed
- Line cord
- Model 4200-SCS Quick Start Manual hardcopy
- Miniature triaxial cables, two per Model 4200-SMU or 4210-SMU, 2m (6 ft)¹
- Triaxial cables, two per Model 4200-PA, 2m (6 ft)
- Interlock cable
- Keyboard with integrated pointing device
- System software and manuals on CD-ROM
- Microsoft Windows XP Professional
- Microsoft C++
- Product Information CD-ROM that contains PDFs of the Quick Reference Guide, Applications Manual, and Reference Manual.

¹Not included when SMU is ordered with a 4200-PA.

Repacking for shipment

Should it become necessary to return the Model 4200-SCS for repair, carefully pack the entire unit in its original packing carton or the equivalent, and include the following:

- Contact Keithley to get a Return Material Authorization (RMA). You can contact Keithley through your local Keithley representative, or by calling the Keithley factory at 1-888-534-8453 (1-888-KEITHLEY), or through the Keithley Web page at www.keithley.com.
- On the shipping label, write ATTENTION REPAIR DEPARTMENT, and the RMA number.

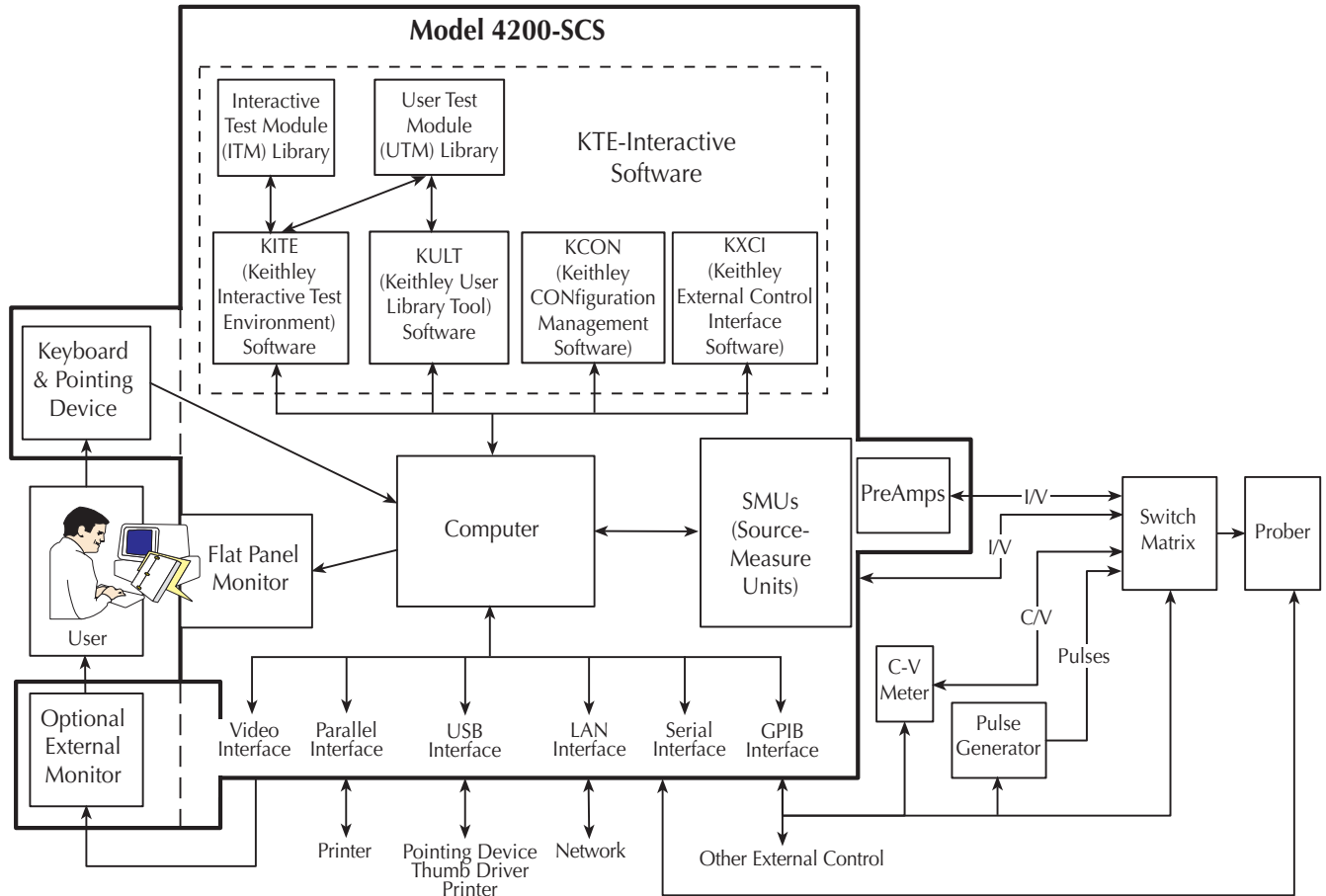
Warranty and contact information is located at the front of this manual.

Becoming familiar with the system

WARNING The safe procedure to power-up the Model 4200-SCS is provided in “Powering the 4200-SCS, later in Section 1 of this manual. Do not turn on the Model 4200-SCS until you have reviewed that information.

The Model 4200 Semiconductor Characterization System (SCS) can automatically characterize IV and CV of semiconductor devices and test structures, using up to eight Source-Measure Units (SMUs). A variety of supported external components enhance the capabilities. See [Figure 1-1](#).

Figure 1-1
4200-SCS summary



Software features

CAUTION When you start one of the KTE Interactive software tools for the first time, you must respond affirmatively to an on-screen license agreement before proceeding further. If you do not respond with a “Yes” answer, your system will be nonfunctional until you reinstall the software.

The following four software tools are used to operate and maintain the 4200-SCS.

- **KITE** — Keithley Interactive Test Environment (*KITE*) is the main Model 4200-SCS device characterization application. You first use *KITE* to organize tests into individual *projects*. You subsequently use *KITE* to manage and execute these projects. You can interactively characterize individual devices or automatically test entire semiconductor wafers.
- **KULT** — The Keithley User Library Tool (*KULT*) allows you to create algorithms (user modules) in the C programming language and to then integrate these modules into *KITE*. The modules can control internal 4200-SCS instrumentation and external instrumentation. You also use *KULT* to create and manage libraries of user modules.
- **KCON** — The Keithley CONFIGuration (*KCON*) utility allows you to configure external GPIB (IEEE-488) instruments, switch matrices, and analytical probers connected to the 4200-SCS. *KCON* also provides basic diagnostic and troubleshooting functions.

- **KXCI** — The Keithley External Control Interface (*KXCI*) allows you to use an external computer to remotely control 4200-SCS SMUs over the GPIB (IEEE-488) bus, using an HP 4145B-style command set. You can do this in either in the 4145 emulation mode or in the 4200 extended mode, which provides access to all 4200-SCS SMU commands and ranges.

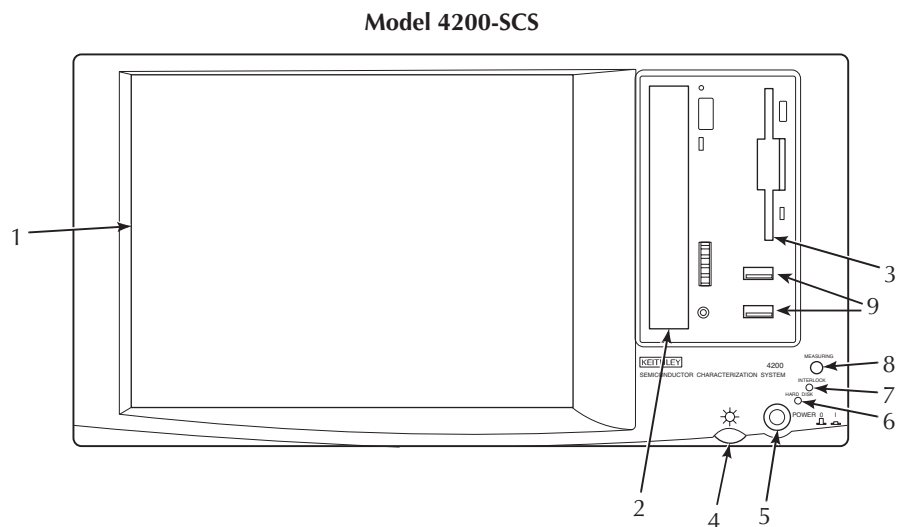
NOTE Discussion of *KXCI* is beyond the scope of this *QuickStart* manual. For the details needed to use *KXCI*, refer to Section 9 of the 4200-SCS Reference Manual, “Keithley External Control Interface (*KXCI*).”

Hardware features and capabilities

Instrument panels

Figure 1-2 shows the 4200-SCS front-panel features.

Figure 1-2
Front panel



1. Display — Displays graphical user interface, data, graphs, and system operation information. (Note: 4200-SCS/C has no display and requires an external CRT.)
2. CD-ROM drive
3. Floppy disk drive.
4. Display brightness — Allows you to set the FPD display to the desired brightness.
5. POWER switch
6. HARD DISK indicator — Turns on when the hard disk is being accessed.
7. INTERLOCK indicator — Turns on when the test fixture interlock is closed.
8. MEASURING indicator — Turns on when measurements are in progress.
9. Two v1.1 USB Ports — Interfaces to peripherals (e.g., pointing devices, printers, scanners, thumb drives, external hard drives, and CD-ROMs).

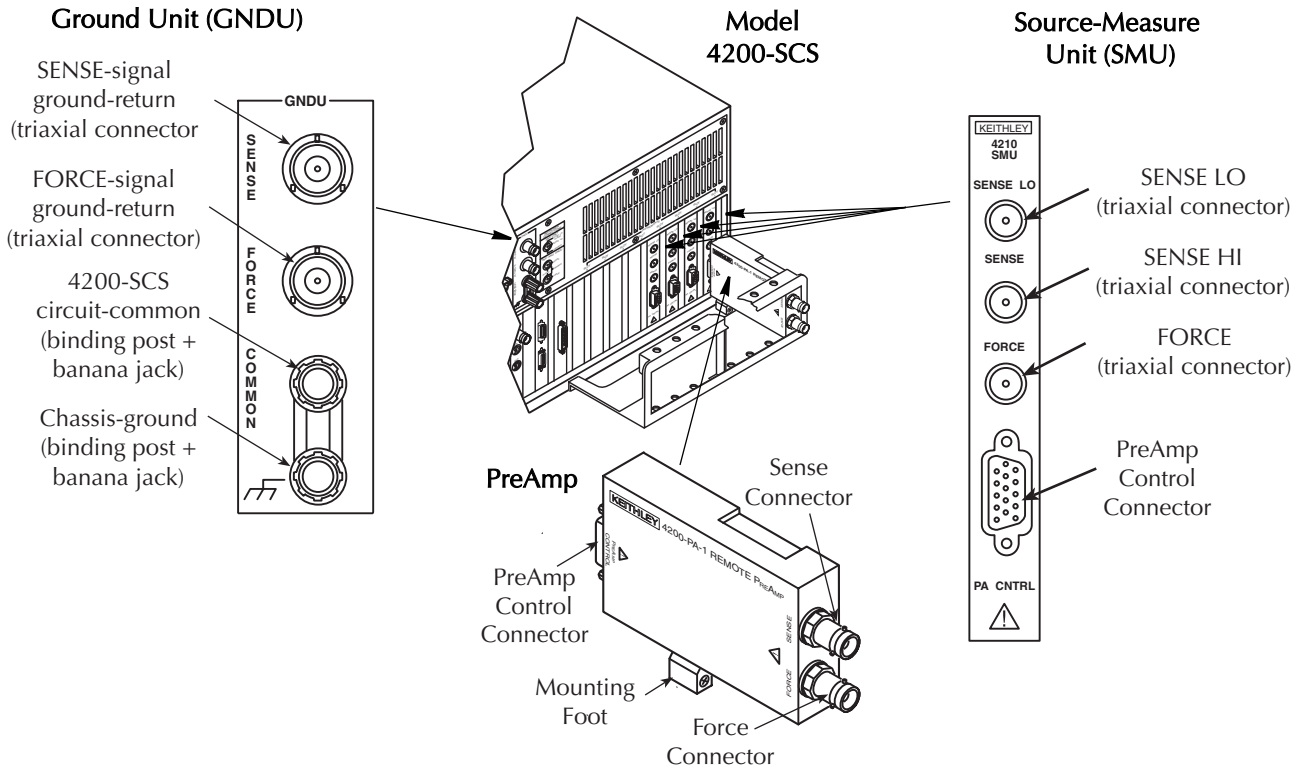
Figure 1-3, Figure 1-7, and Figure 1-8, in following subsections, show the back-panel features.

Source-measure hardware

Source-measure hardware overview

Refer to Figure 1-3. The 4200-SCS mainframe accepts up to eight SMUs, each of which may be used with or without PreAmps. Four of the SMUs may be high-powered, 4210-SMU models.

Figure 1-3
Source-measure hardware overview

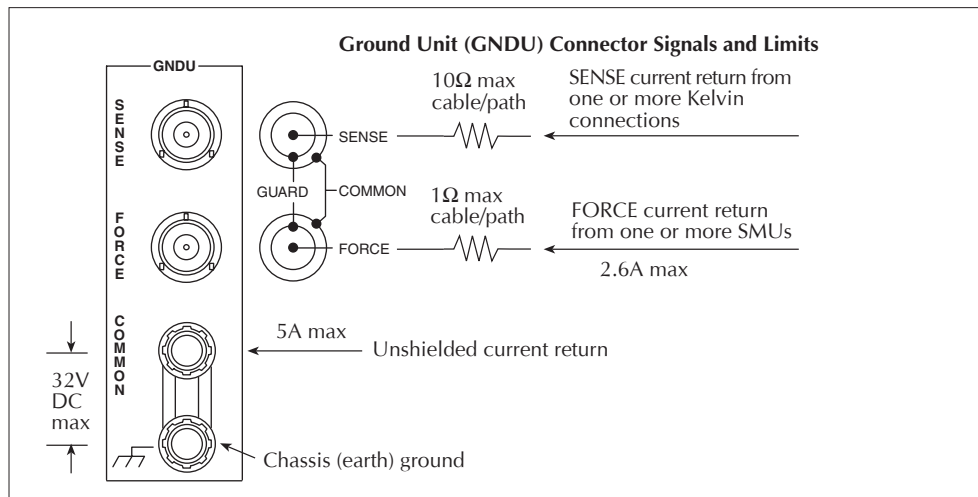
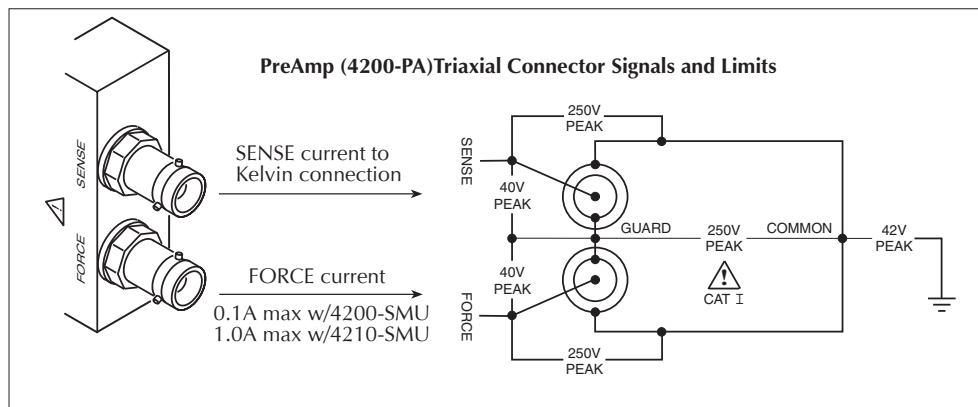
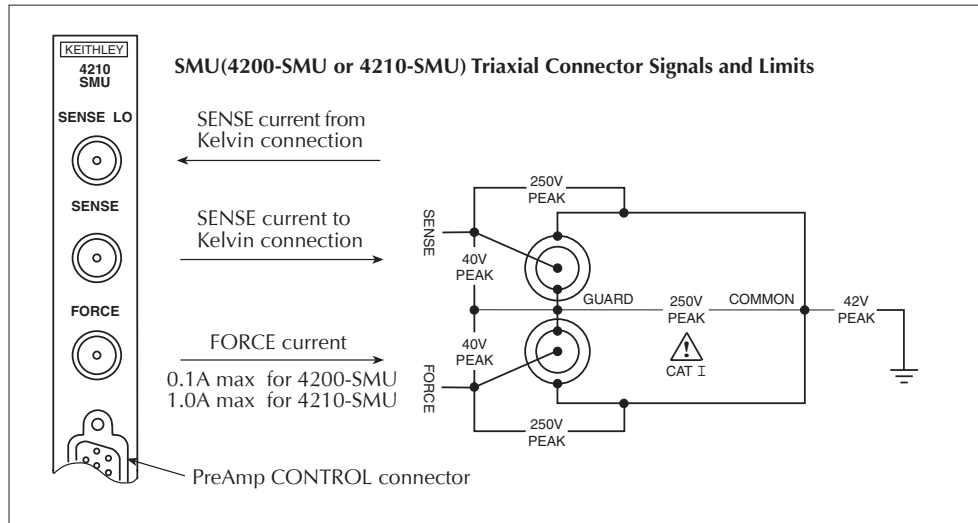


Item shown above	Description	Model	Current ranges (full scale/set resolution)		Voltage ranges (full scale/set resolution)	
			Source	Measure	Source	Measure
Source-Measure unit (SMU)	Performs one of the following: <ul style="list-style-type: none"> Source voltage and measure current and/or voltage Source current and measure voltage and/or current Can be configured to sweep or step source voltages or currents OR to output a constant bias voltage or bias current.	4200-SMU (2.2W out)	105nA / 5pA 1.05µA / 50pA 10.5µA / 500pA 105µA / 5nA 1.05mA / 50nA 10.5mA / 500nA 105mA / 5µA	105nA / 1pA 1.05µA / 10pA 10.5µA / 100pA 105µA / 1nA 1.05mA / 10nA 10.5mA / 100nA 105mA / 1µA	210mV / 5µV 2.1V / 50µV 21V / 500µV 210V / 5mV	210mV / 5µV 2.1V / 50µV 21V / 500µV 210V / 5mV
		4210-SMU (22W out)	As above, <i>plus</i> 1.05A / 50µA	As above, <i>plus</i> 1.05A / 10µA		
PreAmp	Adds lower current ranges to a Model 4200-SMU or Model 4210-SMU.	4200-PA	The <i>additional</i> ranges below: 1.05pA / 50aA 10.5pA / 500aA 100.5pA / 5fA 1.05nA / 50fA 10.5nA / 500fA	The <i>additional</i> ranges below: 1.05pA / 10aA 10.5pA / 100aA 100.5pA / 1fA 1.05nA / 10fA 10.5nA / 100fA		
Ground Unit	Provides need-specific return paths to circuit COMMON.	Part of mainframe	Not applicable	Not applicable	Not applicable	Not applicable

Source-measure connectors

Figure 1-3 above showed the connectors on SMUs, PreAmps, and the GNDU. Figure 1-4 below shows the signal types and absolute limits for each of these connectors.

Figure 1-4
Signal types and absolute limits at source-measure hardware connectors

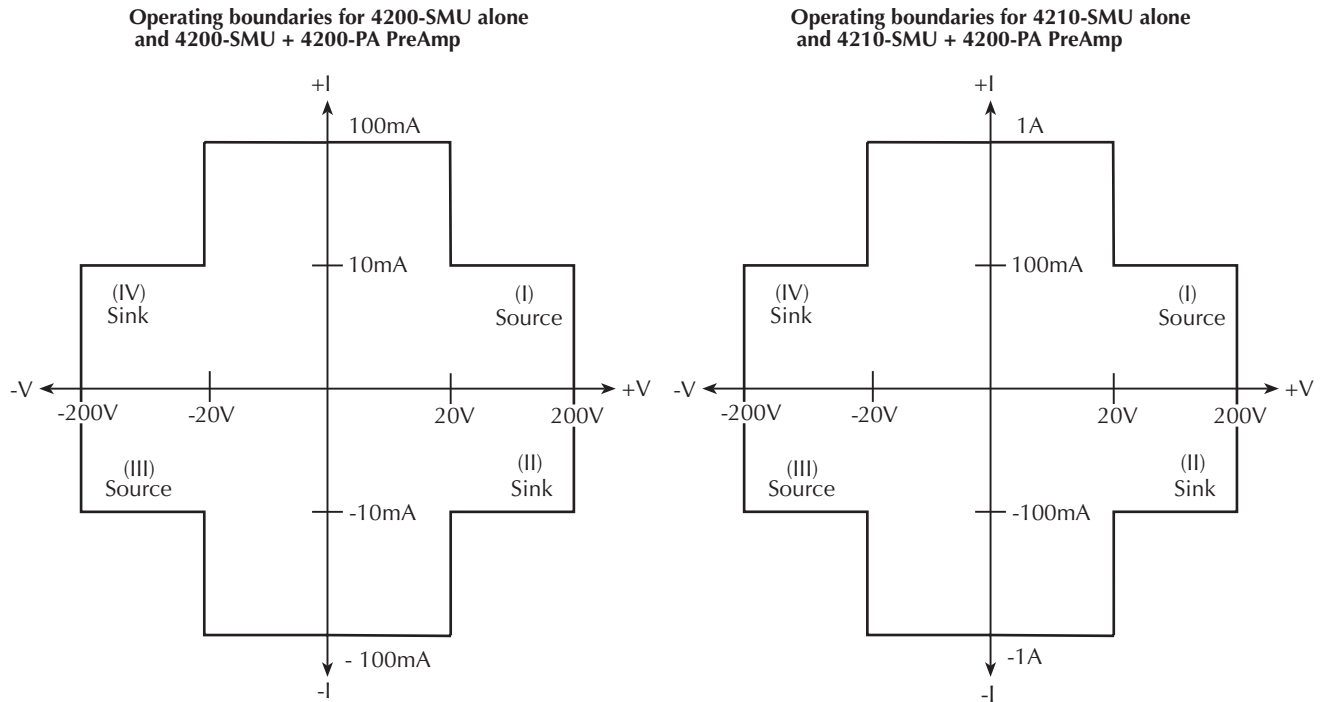


Source-measure operating boundaries

Figure 1-5 covers the normal source/sink operating boundaries for the two models of SMU, alone and with PreAmps.

Figure 1-5

Source-measure operating boundaries



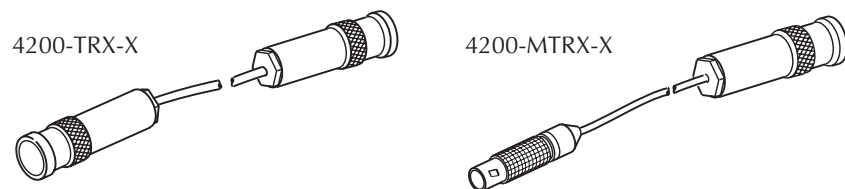
For more information about SMU and PreAmp operating boundaries, see the additional boundary diagrams and discussions in Section 3 of the 4200-SCS Reference Manual.

Source-measure connection cables

You make connections to DUT (device under test) contact devices, such as test fixtures and probers, using supplied Triax cables. Figure 1-6 and the following paragraphs describe the two types.

Figure 1-6

Triax cables for the 4200-SCS



- With PreAmps installed, use the low noise 4200-TRX-X series triax cables, which are terminated with 3-slot triax connectors on both ends. One end of the connects to the PreAmp and the other end connects to the DUT test fixture or probe station.

- Without PreAmps installed, use the 4200-MTRX-X series cables, which have a miniature triax connector on one end and a standard 3-slot triax connector on the other end. The end with the miniature connector connects directly to the SMU, and the other end connects to the test fixture or probe station.

CAUTION With PreAmps installed, NEVER make connections directly to any of the miniature triax connectors on the SMU modules. Otherwise, SMU and/or DUT damage and data corruption may occur.

Locating the system in the proper environment

Locate the Model 4200-SCS such that it will operate within the following ambient temperature and humidity limits:

- Temperature: +15° to +40°C
- Relative humidity: 5% to 80%, non-condensing

NOTE *SMU and PreAmp accuracy specifications are based on operation at 23° ±5°C and between 5% and 60% relative humidity. See the product specifications for derating factors outside these ranges.*

CAUTION To avoid over-heating, operate the unit only in an area with proper ventilation. Allow at least eight inches of clearance at the back of the mainframe to assure sufficient airflow, and adhere to the following:

- Operate the unit in a clean, dust-free environment.
- Keep the fan vents and cooling vents from becoming blocked.
- Do not position any devices adjacent to the unit that force air (heated or unheated) into cooling vents. This additional airflow could compromise accuracy performance.
- When rack-mounting the unit, ensure adequate airflow around the sides, bottom, and back.
- Do not rack-mount high power dissipation equipment adjacent to the Model 4200-SCS.

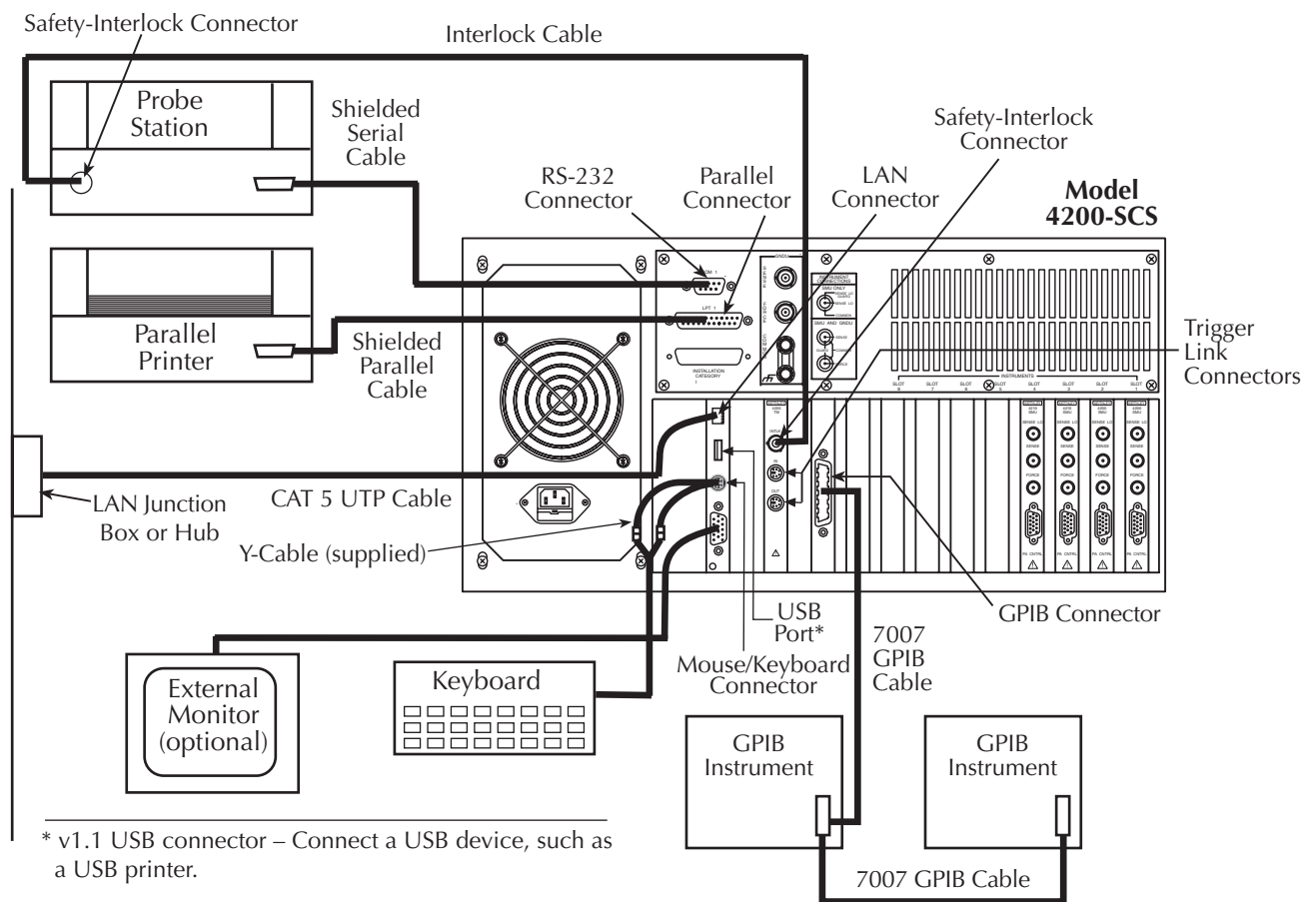
To ensure proper cooling in rack environments with only convection cooling, place the hottest equipment (i.e., power supply) at the top of the rack. Place precision equipment, such as the Model 4200-SCS, as low as possible in the rack, where temperatures are the coolest. Adding spacer panels below the unit helps to ensure adequate airflow.

Connecting system components

WARNING Asserting the interlock will allow the SMU and PreAmp terminals to become hazardous. SMU and PreAmp terminals should be considered hazardous even if the outputs are programmed to be low voltage. Precautions must be taken to prevent a shock hazard by surrounding the test device and any unprotected leads (wiring) with double insulation for 250 volts, Category I.

Figure 1-1 shows how typical system components are installed.

Figure 1-7
Back panel view, system connectors, and system connections

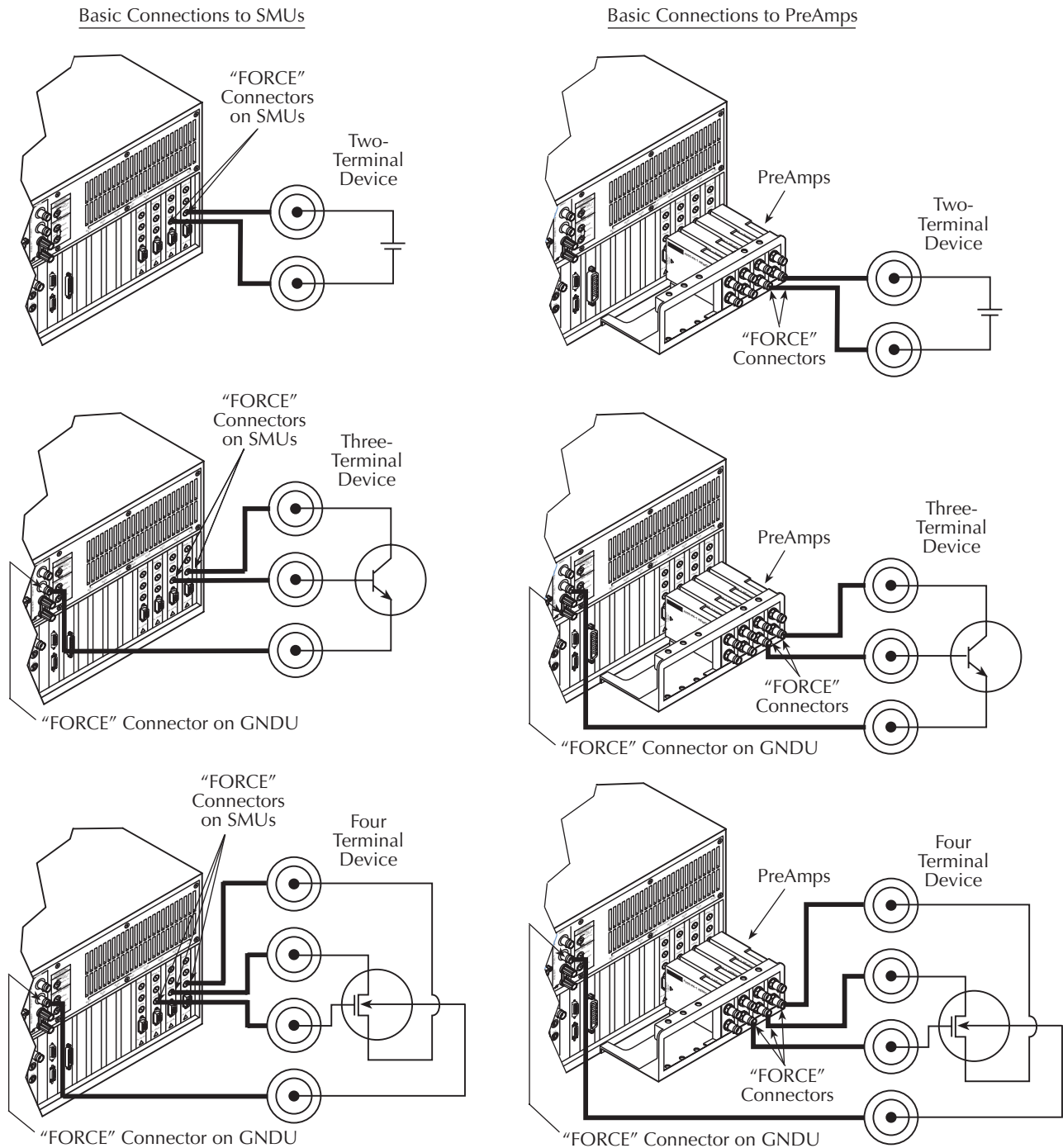


Connecting devices to be tested (DUTs)

Basic device connections

Figure 1-8 shows the basic device connections, independent of the device mounting and manipulation hardware (for example, a test fixture or prober)

Figure 1-8
Back panel and basic device connections to SMUs and Preamps



Device-connection details

Section 4 of the 4200-SCS Reference Manual shows additional SMU and PreAmp connections that meet specific test needs. [Table 1-1](#) briefly describes each diagram and identifies its location.

NOTE *Table 1-1 lists the diagrams in the order in which they appear in the Reference Manual.*

Table 1-1

Additional device connection diagrams in Section 4 of the Reference Manual

Figure title	Connected instruments	Description	Location (subsection title)
“Device shielding”	SMU	Shows how to connect to a DUT that is only shielded.	“Shielding and guarding
“Device guarding”	SMU	Shows how to connect to a DUT that is both shielded and guarded.	“Shielding and guarding
“SMU local sense connections”	SMU	Shows how to connect to a DUT when the SENSE and FORCE terminals are connected together internally in a SMU.	“SMU connections”
“PreAmp local sense connections”	PreAmp	Shows how to connect to a DUT when the SENSE-to-FORCE terminals are connected together internally in a PreAmp.	“PreAmp local sense connections”
“Ground unit and SMU local sense connections”	Multiple SMUs and GNDU	Shows how to connect multiple SMUs to a DUT(s), using a common, GNDU ground-return path, when the SENSE and FORCE terminals are connected together internally.	“Ground unit and SMU local sense connections”
“Ground unit and SMU remote sense connections”	Multiple SMUs and GNDU	Shows how to connect multiple SMUs to a DUT(s), using a common, GNDU ground-return path, when the SENSE and FORCE terminals are connected remotely to the DUT(s) [Kelvin connections].	“Ground unit and SMU remote sense connections”
“Ground unit and PreAmp local sense connections”	Multiple PreAmps and GNDU	Shows how to connect multiple PreAmps to a DUT(s), using a common, GNDU ground-return path, when the SENSE and FORCE terminals are connected together internally.	“Ground unit and PreAmp local sense connections”
“Ground unit and PreAmp remote sense connections”	Multiple PreAmps and GNDU	Shows how to connect multiple PreAmps to a DUT(s), using a common, GNDU ground-return path, when the SENSE and FORCE terminals are connected remotely to the DUT(s) [Kelvin connections].	“Ground unit and PreAmp remote sense connections”
“Typical SMU common connections”	Multiple SMUs	Shows how to make COMMON connections when all of the DUT terminals connect to SMU FORCE terminals — for example, when a SMU is programmed to force 0.0V on a FET source terminal. In such a case, one SMU connects a selected FORCE terminal internally to COMMON.	“SMU circuit COMMON connections”

Powering the 4200-SCS

The Model 4200-SCS operates from a line voltage in the range of 100 to 240VAC, at a frequency of 50 or 60Hz. Line voltage is automatically sensed, but line frequency is not (see step 6 below).

Connect and power your unit as follows:

1. Check to be sure the operating voltage in your area is compatible.

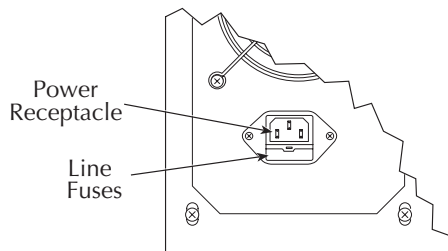
CAUTION Operating the instrument on an incorrect line voltage may cause damage, possibly voiding the warranty.

NOTE To avoid possible problems caused by electrical transients or line voltage fluctuations, the Model 4200-SCS should be operated from a dedicated power source.

2. Before plugging in the power cord, make sure the front panel power switch is OFF.
3. Connect the female end of the supplied power cord to the AC receptacle on the rear panel (Figure 1-9).

WARNING Use only the supplied, grounded line cord, or the equivalent, to assure proper safety grounding.

Figure 1-9
Line power receptacle



4. Connect the other end of the supplied line cord to a grounded AC line power receptacle.

WARNING The power cord supplied with the unit contains a separate ground for use with grounded outlets. When proper connections are made, instrument chassis is connected to power line ground through the ground wire in the power cord. Failure to use a grounded outlet may result in personal injury or death due to electric shock.

5. Turn the power ON using the front-panel power switch. The Model 4200-SCS performs a series of self-tests. If it detects a failure, the unit displays an error message.

NOTE If a problem develops, return the Model 4200-SCS to Keithley Instruments, Inc. for repair. Refer to "Repacking for shipment" for more information on returning the Model 4200-SCS to the factory.

If the unit passes the self-tests, it automatically boots the system software and displays the start-up screen.

6. Although the unit does not sense power line frequency at power-up, Keithley ships your 4200-SCS with line frequency settings that match the line frequency that was specified on the order — either for 50Hz or 60Hz. However, if necessary, you can change the line frequency setting using the *KCON* utility. (Refer to “Keithley CONFIGuration Utility (KCON),” in Section 7 of the 4200-SCS Reference manual.)

NOTE *Operating the Model 4200-SCS with the wrong line frequency setting may result in noisy readings because the line frequency setting affects SMU line frequency noise rejection.*

7. Warm up the unit. The Model 4200-SCS can be used immediately after being turned ON. However, to achieve rated measurement accuracy, warm up for at least 30 minutes.

Configuring the system

You do not need to perform system configuration operations if you use only *internal* instruments — factory-installed SMUs, PreAmps, and the Ground Unit (GNDU). The 4200-SCS automatically detects internal instruments and configures the system appropriately for *local* operation.

However, after adding supported *external* instruments — switch matrices, external GPIB instruments, probe stations, etc. — you must properly configure the system so that *KITE* and *KXCI* can utilize these resources. Also, if you need *remote* operation of the 4200-SCS, through *KXCI*, you must further configure the system.

Perform these configurations using the *Keithley CONFIGuration utility (KCON)*. [Figure 1-10](#) overviews *KCON* features. For details on using the tool, refer to Section 7 of the 4200-SCS Reference Manual, “Keithley CONFIGuration utility (*KCON*)”

NOTE *To start the tool, double-click the KCON icon on the Windows desktop:*



If KCON is running, you cannot start KITE or KXCI. If KITE or KXCI is already running, you can start KCON but cannot save any system configuration changes that you may make.

*If you select **KI System Configuration** in the KCON Configuration Navigator, the Workspace displays a summary of the entire system configuration.*

*If you select **KI 4200 SCS** in the Configuration Navigator, the Workspace displays abbreviated system properties and SMU slot assignments and allows you to do the following:*

- *Specify the correct powerline frequency (60Hz or 50 Hz) for your installation.*
- *Configure the system for remote control via KXCI (Keithley External Control Interface).*
- *Specify a particular user library to be the active user library. Otherwise, the active user library defaults to `C:\S4200\kiuser\usrlib`.*

Figure 1-10
KCON overview

File Menu:

- Save Configuration (Ctrl+S):** Saves the revised system configuration, making it the working configuration for KITE, KULT, or KXCI. If you do not save the changes, the configuration reverts to the last-saved configuration.
- Save Configuration as Web Page (Ctrl+W):** Saves the system configuration as an HTML file that can be viewed in a web browser. If you first select **KI System Configuration** in the Configuration Navigator, this menu item generates a web page that displays general 4200-SCS system information.
- Print Configuration (Ctrl+P):** Prints the general system configuration information — the information that displays in the KCON Workspace when **KI System Configuration** is selected in the Configuration Navigator.
- Exit:** Closes the KCON program. If you revised but did not save the configuration, KCON reminds you.

External Instruments Menu:

- Add External Instrument:** Adds a supported external instrument that is selected by category in the first submenu and, where applicable, by model number in the second submenu. External instruments are controlled by *KITE* User Test Modules (UTMs). UTMs are in turn connected to *KULT* user modules — libraries of which are included with the 4200-SCS.
- Delete External Instrument:** Removes, from the system configuration, the external instrument that is selected in the Configuration Navigator. (Selecting an external instrument enables this item — “Delete External Instrument”).

Tools Menu:

- Validate Configuration (Ctrl+V):** Automatically tests the system configuration for conflicts or instrument communication problems. Applies to all instruments except probe stations, test fixtures, and general purpose test instruments.
- Formulator Constants... (Ctrl+F):** Modifies the *default*, automatically assigned Formulator constants for newly created *KITE* test modules. The Formulator is a programmable in-test and post-test calculation tool for test data.

Help Menu:

- 4200-SCS Complete Reference (F1):** Automatically starts the web browser and loads the preinstalled Complete Reference documents, including the 4200-SCS User and Reference Manuals, product data sheets, and application notes.
- Generate Technical Support Files...:** Prompts you for contact information, analyzes your 4200-SCS, and stores the results on a diskette. The diskette, when sent to Keithley, helps Technical Support to resolve problems on
- About KCON...:** Displays a window that contains version and copyright information.

Configuration Navigator:

- Internal instruments:** Factory-installed SMUs, PreAmps, and ground unit.
- External Instruments:** User-installed switch matrix, capacitance meters, pulse generators, probe station, test fixture, and general-purpose test instruments.

Workspace:

Displays configuration properties for the instrument that is selected in the Configuration Navigator, and — for external instruments — allows changing of configurable properties, such as the GPIB address shown above.

Properties & Connections:

- Instrument Properties:** Model: Keithley 590 CV Analyzer, GPIB Address: 15
- Matrix Connections:**

Terminal Name	Connection	Terminal ID
OUTPUT	NC	CMTR1
INPUT	NC	CMTR1L

Note: A callout points to the selected instrument in the Configuration Navigator and the corresponding properties in the Workspace, stating: "Selected instrument for which this configuration information is displayed".

2

Designing and Executing Tests

WARNING When you start one of the KTE Interactive software tools for the first time, you will be required to respond affirmatively to an on-screen license agreement before proceeding further. If you do not respond with a “Yes” answer, your system will be nonfunctional until you reinstall the software.

Understanding the 4200-SCS test hierarchy and terminology

KITE organizes tests in the hierarchy below, consistent with semiconductor-wafer organization (though *KITE* uses the same scheme for discrete semiconductors). Relevant definitions follow.

- Project
 - Sites
 - Subsites
 - Devices
 - Tests: Interactive Test Modules (ITMs) and User Test Module (UTMs)

Project

The start-to-finish actions and test locations involved in evaluating a semiconductor wafer or other collection of circuits. You create and execute projects via the *KITE* graphical user interface

Site

Each die on a semiconductor, combined with its accompanying test structures — the *subsites*.

Subsite

Every wafer location that a prober can move to and contact at any one time. This typically corresponds to a single test structure—or other combination of *devices* that are tested as a group.

Device

An individual component on which *tests* are performed— transistor, diode, etc. capacitor, etc.

Test

The detailed definition of how *KITE* performs a specific type of parametric characterization on a *device*, including associated data analyses and parameter extractions. The definition includes the following for each terminal of the device:

- The desired voltage or current forcing functions (stimuli).
- The desired voltage and/or current measurements.

There are two classes of tests: *Interactive Test Modules (ITMs)* and *User Test Module (UTMs)*. You use the same *KITE* data-analysis functions both for *ITM* data and for *UTM* data.

Interactive Test Module (ITM)

A test that allows the user to define a test interactively via a graphical user interface.

User Test Module (UTM)

A test that you define primarily by programming a C-language user module — using *KULT* — but in which you typically configure key test parameters using a graphical user interface.

Becoming familiar with the *KITE* interface

KITE's graphical user interface (GUI) allows you to do the following:

- Interactively build and edit projects, using the Project Navigator.
- Configure off-the-shelf ITMs or create new, customized ITMs from off-the-shelf templates.
- Create UTMs from supplied or user-programmed C-code modules.
- Automatically execute tests and associated operations (switch matrix connections, prober movements, etc.), including:
 - A single test for one selected device (transistor, diode, resistor, capacitor, etc.).
 - A sequence of tests for one selected device.
 - A sequence of tests for multiple devices—for example, all of the devices at a subsite
 - The test sequences of an entire Project — which may include prober touchdowns at every subsite of just one site or at every subsite of multiple sites

- View test results, numerically and graphically.
- Analyze test results using built-in parameter extraction tools.
- View the analysis results numerically and graphically.

Figure 2-1 below summarizes key parts of the *KITE* main window. Subsequent subsections highlight the Project Navigator and Site Navigator parts of this window, as well as key GUIs that can be accessed from this window.

Figure 2-1
KITE interface overview

Project Navigator:

Where a Project is assembled, edited, displayed, and executed. (A Project defines a series of tests, of various devices, at one or more locations.) Double-clicks here lead to definition, configuration, and tool screens. A selection here defines the starting location when only part of the Project is to be executed.

Site Navigator:

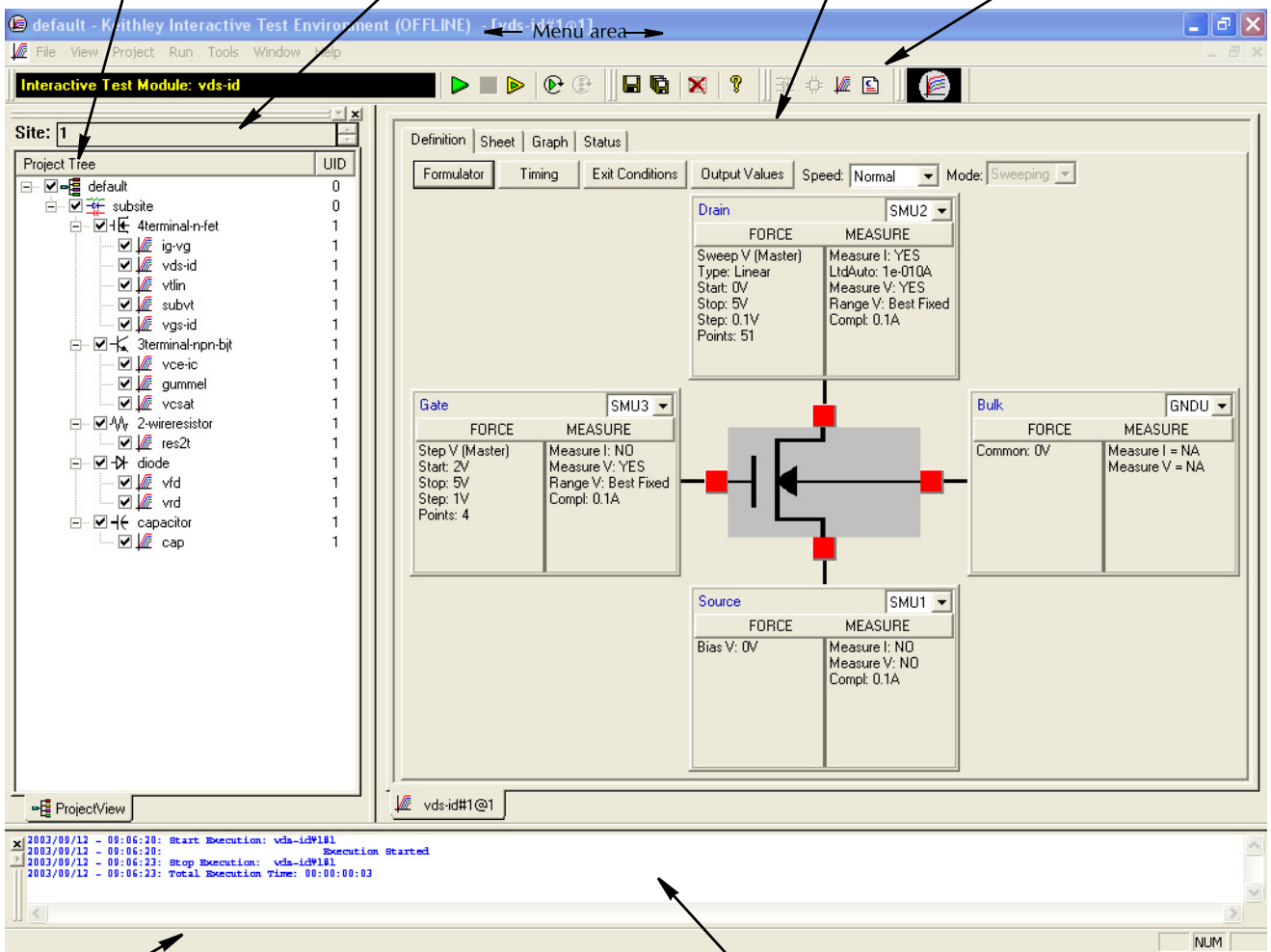
Displays the current site—typically a die on a semiconductor wafer—that is being evaluated by the Project. Allows selection of the single site to be evaluated when only part of the Project is to be executed.

KITE Workspace:

Displays the variety of screens, windows, tabs, message boxes, etc. that are used: 1) to configure all Project components; 2) observe evaluation results; and 3) analyze evaluation results.

Toolbar Area:

Displays a variety of icons that can be used to: 1) start and stop all or part of a Project; 2) verify Project execution; 3) insert Project components; 4) save and print Project files; and 5) view *KITE* help.



Status bar:
Displays descriptions of menu and toolbar items.

Message area:
Displays KITE execution and error messages.

Understanding the Project Navigator

The Project Navigator is the primary interface for building, editing, and viewing a Project and for specifying and accessing each Project component. Note the following:

- You can add a component at any point in the project, using menu items or toolbar buttons.
- Single-clicking on a Project Navigator component selects it as one of the following:
 - A location at which you can add a new component or delete an existing component.
 - A part of the Project — subsite, device, or individual test — to be executed alone.
- Double-clicking on a Project Navigator component opens configuration screens for the component and — as appropriate — test results, analysis tools, and status information.

Figure 2-2 describes the components in a typical Project Navigator pane.

Figure 2-2
Project Navigator

Project:
Defines and sequences all subsites tested, all devices tested, and all tests/operations to be performed at each site—which typically corresponds to one die on a wafer.

Subsite Plan:
Defines and sequences all devices tested and all tests performed at a given prober touchdown location. There are typically multiple subsites per site.

Device Plan:
Defines and sequences all tests for a specific device—a transistor, diode, resistor, etc.—at a given subsite.

Interactive Test Module (ITM):
Completely defines a parametric test without programming, using a series of easily configured graphical user interfaces (GUIs). Provides for display of both raw data and analyzed data, numerically and graphically, in real time.

User Test Module (UTM):
Defines an operation—a special test, a setting of switch-matrix connections, a prober advance, an external instrument operation, etc.—via a C-programmed user module that is connected to the UTM and is configured with user-supplied parameter values. (Several UTMs may be associated with the with the same user module.) Configuration is done via a simple graphical user interface. The user module that is connected to the UTM may be available in a Keithley-supplied library or may be created by the user with KULT. Provides display of both raw and analyzed test data, where applicable, numerically and graphically.

Initialization Steps (at top) and Termination Steps:
Define operations (UTMs only) that initialize test equipment at the beginning of a test session and process results or reset instrumentation at the end of an execution sequence. The initialization and termination steps are executed only once during a test session, even if the Project is executed several times (e.g., to evaluate multiple sites on a wafer).

Project Navigator Checkboxes:
Project Navigator Checkboxes are used to enable or disable the Project Plan, a Subsite Plan, a Device Plan or individual tests (ITMs and UTMs). Clicking a checkbox either inserts a check mark in the box (enable) or

Unique ID (UID) number:
A number assigned to each instance of a same-named project component. If there is only one instance of a Project component of a given name (as in the Project at left), each component has a UID of 1. However, if multiple components, e.g., ITMs or UTMs, of a given name are inserted into a project, they are assigned multiple UIDs. As long as a component remains in the Project, its UID never changes—even if a lower-numbered same-named component is deleted from the Project. (Note: if UID = 0 for a component, that component can occur only once in the Project.)

Component	UID
probesubsites	0
InitializationSteps	0
prober-init	1
Subsite1	0
4terminal-n-fet	1
prober-contact	1
connect	1
vds-id-1x	1
3terminal-npn-bit	1
connect	2
vce-ic-1x	1
prober-ss-move	1
Subsite2	0
4terminal-n-fet	2
prober-contact	2
connect	3
vds-id-2x	1
3terminal-npn-bit	2
connect	4
vce-ic-2x	1
prober-ss-move	1
TerminationSteps	0
prober-separate	1
prober-prompt	1

Understanding Interactive Test Modules (ITMs) and User Test Modules (UTMs)

KITE tests and operations execute through ITMs and UTMs. Figure 2-3 relates “vds-id” ITM and “rdson” UTM windows to their locations in the example KITE Project.

Figure 2-3
ITMs and UTMs in the Project Navigator

The figure shows a Project Navigator window on the left and two configuration windows on the right. The Project Navigator lists various test modules under a '4terminal-n-fet' category, including 'vds-id', 'subvt', 'vgs-id', 'ig-vg', 'rdson', and '3terminal-np'. The 'vds-id' and 'rdson' modules are highlighted with callout lines pointing to their respective configuration windows. The 'vds-id@1' window shows a circuit diagram of a MOSFET with four test points (Drain, Gate, Source, Bulk) and associated SMU (Source Measurement Unit) settings for each. The 'rdson@1' window shows a table of input/output parameters and a description of the test procedure.

Name	In/Out	Type	Value
1	Vg	Input	DOUBLE 2.000000e+000
2	Vd1	Input	DOUBLE 5.000000e-001
3	Vd2	Input	DOUBLE 2.000000e+000
4	GatePin	Input	INT 5
5	SourcePin	Input	INT 3
6	DrainPin	Input	INT 4
7	BulkPin	Input	INT 6
8	Id1	Output	DOUBLE_P
9	Id2	Output	DOUBLE_P

Table 2-1 summarizes the primary differences between ITMs and UTMs

Table 2-1
Primary differences between an ITM and a UTM

ITM	UTM
Is always configured via a series of systematic, interactive graphical user interfaces (GUIs), without programming.	Created and configured by connecting a UTM name to a user module and entering or modifying the input parameter values.
Is flexible. Keithley provides default ITM configurations for most standard devices and tests; you may be able to perform many of your evaluations with minimal or no changes to the default parameters. However, you can create a new ITM, or customize any existing ITM, to perform a wide variety of static and dynamic evaluations. You can even create an ITM for a generic “n-terminal” device.	Is task-specific. However, you can modify the source code for a user module that is connected to a UTM and recompile it to create a new user module. Keithley provides the source code for most of the user modules that are shipped with the 4200-SCS. User modules are modified using KULT.
Performs exclusively tasks on internal 4200-SCS instrumentation.	Performs tasks on internal 4200-SCS instrumentation or on any instrument that is connected to the 4200-SCS IEEE-488 bus or the 4200-SCS RS-232 port.
Is used exclusively for parametric testing.	May be used to perform almost any test-related task.
Generated data updates the Data worksheet ¹ in real time, as the test executes.	Generated data updates the Data worksheet ¹ <i>after</i> test execution is complete.

¹ Refer to “Viewing test results numerically via the Sheet tab Data worksheet,” in Section 3.

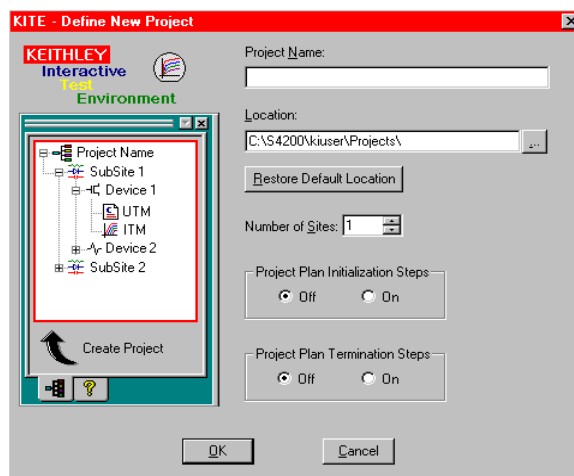
Building a Project

This subsection shows how to build a Project from standard 4200-SCS library ITMs and library and user-defined UTMs

Define the new Project

1. In the File menu, click **New Project**. The Define New Project window opens, with the default settings as shown in [Figure 2-4](#).

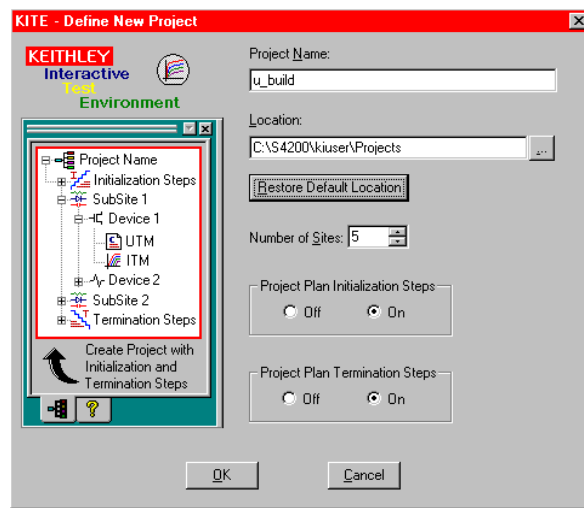
Figure 2-4
Define New Project window



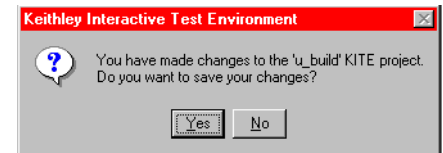
2. Configure the Define New Project window as follows:
 - **Project Name** — Enter the Project name.
 - **Location** — If you don't want the default folder, enter the storage folder for the Project.
 - **Number of Sites** — Specify the number of sites to be evaluated by the Project
 - **Restore Default Location** — Clicking restores default folder as the Project location.
 - **Project Plan Initialization Steps** — Click **On** if you plan to insert one or more initialization UTMs at the start of the Project.
 - **Project Plan Termination Steps** — Click **On** if you plan to insert one or more termination UTMs at the end of the Project Plan.

Figure 2-5 shows configuration of the new **u_build** Project Plan

Figure 2-5
Define New Project window configured for the **u_build** Project Plan

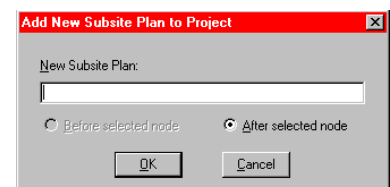
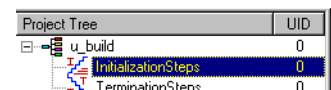


3. Click **OK**. The Project Navigator appears, reflecting the chosen configuration.
4. Click the **Save All** toolbar button ().
5. To close the Project Plan at any time, select **Close Project** in the **File** menu. If you did not save the Project Plan just before, the dialog box shown at right below appears; click **Yes**.



Insert the Subsite Plans

1. In the Project Navigator, select the component (node) below which to insert the first Subsite Plan. At right, **Initialization Steps** is selected for the **u_build** Project.
2. Add a Subsite Plan to the Project Plan as follows:
 - a. On the Project Plan toolbar, click the **Add Subsite Plan** button (). The Add New Subsite Plan to Project dialog box appears. See at right.
 - b. Enter the name for the new Subsite Plan in the dialog box




- c. Click **OK**. The Subsite Plan is inserted below the selected component., as shown at right.
3. Insert additional Subsite Plans, as needed, by repeating steps 1 and 2.

Project Tree	UID
u_build	0
InitializationSteps	0
subsite_a	0
TerminationSteps	0

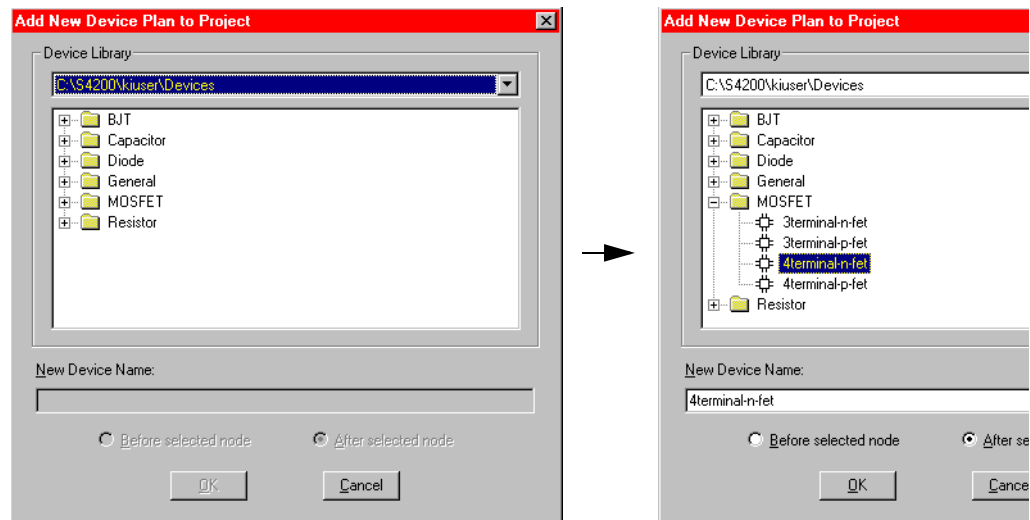
Insert the Device Plans

To insert a Device Plan from the default 4200-SCS device library, do the following:

1. In the Project Navigator, select the Subsite Plan below which to insert the Device Plan. See the example at right.
2. Add the Device Plan to the Project Plan as follows:
 - a. In the Project Plan toolbar, click the **Add New Device Plan** button (). The Add New Device Plan to Project window appears. See the left screen capture in [Figure 2-6](#).

Project Tree	UID
u_build	0
InitializationSteps	0
subsite_a	0
subsite_b	0

Figure 2-6
Selecting a new device plan from the 4200-SCS device library



- b. In the Add New Device Plan to Project window, select a new Device Plan from the default device library. See right screen capture in [Figure 2-6](#) above.
- c. Click **OK**. The Device Plan is inserted below the selected component. See the example at right.

u_build	0
InitializationSteps	0
subsite_a	0
4terminal-n-fet	1
subsite_b	0

Insert the ITMs

NOTE You can insert an ITM for a given Device Plan only if the insertion is appropriate, as follows:

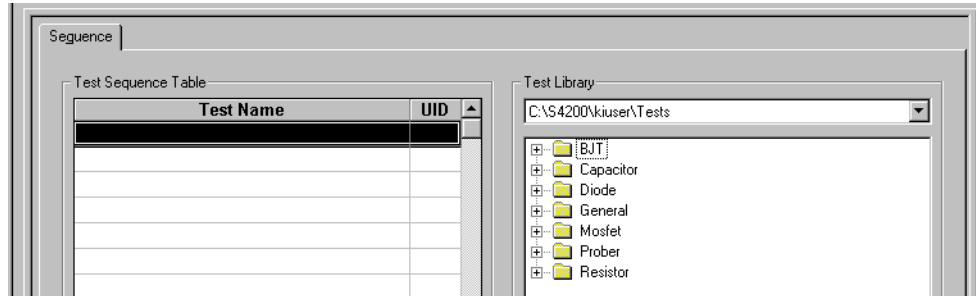
- The number of device terminals required by the ITM is not greater than the number of terminals on the target device. (For example, you cannot use a BJT ITM to test a diode.)
- Each terminal name required by the ITM is present on the target device.

To insert an ITM from the default 4200-SCS library, do the following:

1. In the Project Navigator, select the Device Plan component below which to insert the first ITM. See example at right.
2. Double-click the selected Device Plan name. The Device Plan window appears, displaying device-category folders that contain device-appropriate ITMs. See [Figure 2-7](#).

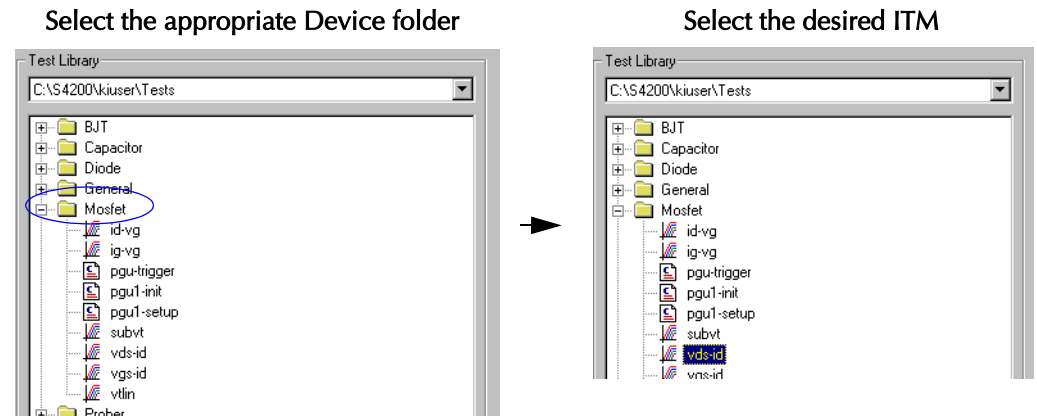


Figure 2-7
Device Plan Window



3. Click the folder corresponding to the device type for which you are adding the ITM. A list of ITMs (and, typically, UTMs) appears. See the example at the left of [Figure 2-8](#).

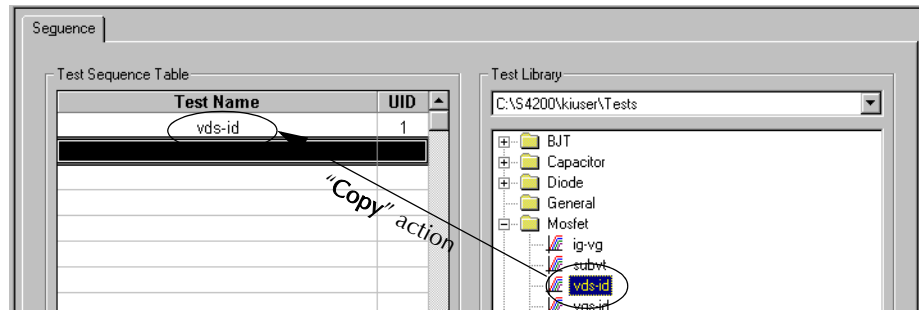
Figure 2-8
Selecting an ITM from the 4200-SCS device library



4. Select the desired ITM. See the example at the right of [Figure 2-8](#) above.
5. Many ITMs contain sample data. If you wish to include this data when you insert the ITM, check the **Include Data** checkbox (located at the lower right corner of the Device Plan window). See at right.
6. In the Device Plan window, below the list of ITMs, click the **Copy** button. The ITM is added to the **Test Sequence Table** of the Device Plan window. See [Figure 2-9](#).



Figure 2-9
Adding an ITM to the Test Sequence Table



7. If, under **Test Sequence Table**, an ITM is not at the preferred position in the sequence, do the following:
 - a. Select the ITM to be moved.
 - b. Use the **Move Up** button or the **Move Down** button to reposition the ITM.
8. In the Device Plan window, below the list of ITMs, click the **Apply** button. The ITM is added to the Project Navigator. See the example at right.



Insert the UTM

Inserting a library UTM

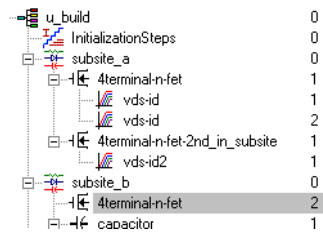
If a needed UTM is available in the C:\S4200\kiuser\Tests library, or in a personal library, you can insert it as you would an ITM (per “Insert the ITMs”), except as follows:

- You can insert a UTM (and only a UTM) below **Initialization Steps** and **Termination Steps** in the Project Navigator. You cannot insert an ITM in these locations.
- If you insert multiple instances of a UTM under the same name, the parameter values are unique for each instance.

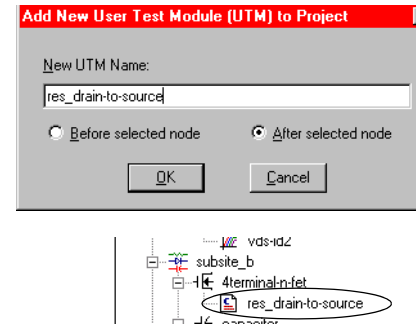
Inserting a new, name-only UTM

If a needed UTM is not available in the C:\S4200\kiuser\Tests library, or in a personal library, you must create one. Initially insert a new, name-only UTM into the Project as follows:

1. In the Project Navigator, select the component below which you’ll insert the UTM, as shown at right. You can insert UTMs at the following places:
 - Below Device Plans, initialization steps, and termination steps.
 - Above and below ITMs and other UTMs. (for simplicity, the instructions in this subsection reflect adding the UTM below an ITM or UTM.)




2. Click the **Add New UTM** toolbar button. Add New User Test Module (UTM) to Project dialog box appears. (As at right, except without UTM name.)
3. In the Add New User Test Module (UTM) to Project dialog box, enter the desired name for the UTM. See at right
4. Click **OK**. The new name-only UTM is inserted into the Project Plan. See at right.
5. Before using the UTM, define and configure it, as will be described subsequently in “Defining and configuring the Project UTMs.”



If you want to save the UTM in a test library, do so as described in Section 6 of the 4200-SCS Reference Manual, under “Submitting devices, ITMs, and UTMs to libraries.”

Save the Project

When you finish entering the Project, save it by clicking the **Save All** toolbar button ().

Defining and configuring the Project ITMs

Understand the ITM Definition tab

To define an ITM, use the ITM **Definition** tab. Display it by double-clicking on the ITM name in the Project Navigator. [Figure 2-10](#) shows and describes the ITM **Definition** tab, in this case for the **vds-id** ITM, which is part of the **example** project (shown previously in [Figures 2-2](#) and [2-3](#)).

Figure 2-10
ITM Definition tab — and neighboring tabs

The screenshot shows the ITM Definition tab interface. At the top, there are tabs for Definition, Sheet, Graph, and Status. Below the tabs are several buttons: Formulator, Timing, Exit Conditions, Output Values, Speed (Normal), and Mode (Sweeping). The main area contains a schematic diagram of a device with four terminals: Drain (SMU2), Gate (SMU3), Bulk (GNDU), and Source (SMU1). Each terminal has a 'FORCE' and 'MEASURE' section with various parameters. A workspace window tab labeled 'vds-id-1x...' is visible at the bottom left.

Graph tab: Graphical test and analysis results.

Status tab: Test definition and configuration status.

Exit Conditions button: Click to set the test exit condition when compliance occurs.

Timing button and Speed combo box: Custom and preconfigured test-timing/noise-rejection selections.

Mode combo box: Allows sampling vs. time mode instead of sweeping mode.

Sheet tab: Numerical test and analysis results and test settings.

Formulator: Mathematical test results analysis tool.

Output Values button: Click to export Output Values for this test into the Subsite Data sheet.

FORCE MEASURE button: Click to configure the ITM.

Instrument object: Displays a summary of the settings for the instrument that is connected to a particular device terminal.

Workspace window tab: You can quickly access a Project-component window that is active in the KITE workspace — several can be active simultaneously — by selecting its Workspace tab (Must be enabled. See “Specifying environmental preferences” in Reference Section 6.)

Instrument-selection combo box: Assigns a 4200-SCS instrument to this device terminal.

Schematic of the device being tested by this ITM.

An ITM **Definition** tab defines the ITM as follows:

- Schematically displays the type of device to be tested by the ITM (FET, BJT, capacitor, etc.).
- Next to each terminal of the device, displays an *instrument object*, which acts as follows:
 - Identifies the terminal (e.g. as gate, drain, source, collector, anode, etc.)
 - Identifies and allows assignment/reassignment of the terminal to match the SMU, GNDU, or open circuit that is physically connected to the terminal during the test.
 - Displays the present forcing-function and measurement options for the terminal.
 - Identifies and allows assignment and configuration/reconfiguration of SMU forcing function and measuring options. A single-click of the **FORCE MEASURE** button of the displays the Forcing Functions/Measure Options window for the terminal.
- Provides access to the **Formulator**, which allows in-test and post-test data computations.
- Allows setting of preconfigured **Speed** and/or custom **Timing** parameters for the ITM.
- Displays the present test **Mode** — **Sweeping** or **Sampling**.

Understand the ITM forcing functions

Table 2-2 summarizes the available ITM *forcing functions*, which tell the 4200-SCS how to apply static or dynamic voltage or current conditions to device terminals.

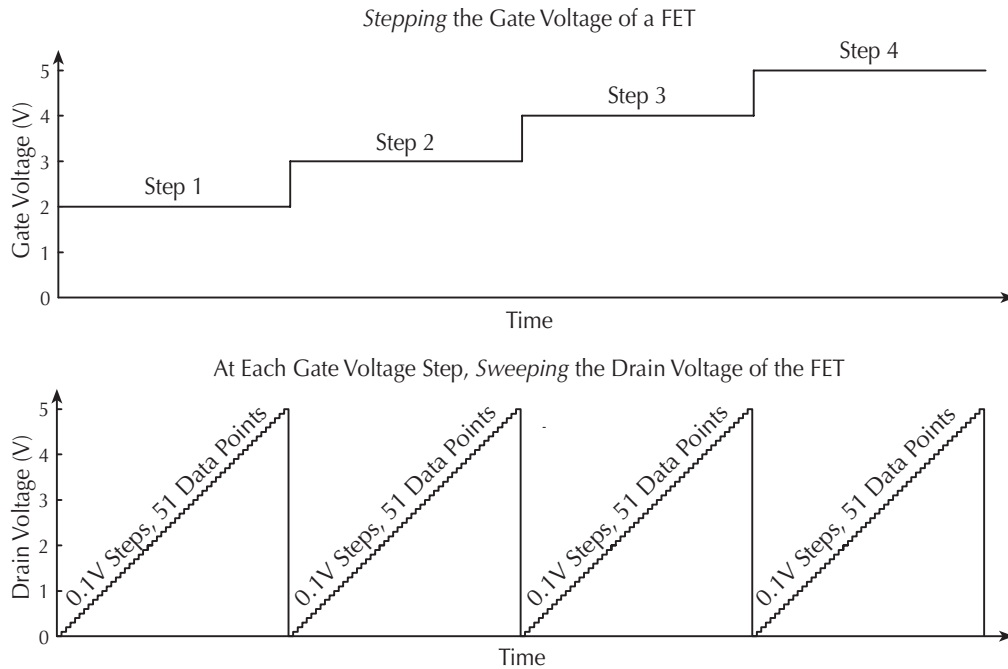
Table 2-2
Forcing function summary

General type	Name	Description and graphical illustrations
Static	Open	Maintains a zero-current state at the terminal, subject to the maximum <i>voltage</i> compliance of the connected SMU.
	Common	Maintains a zero-voltage state at the terminal, subject to the maximum <i>current</i> compliance of the connected SMU.
	Current Bias	Maintains a selected constant-current state at the terminal, subject to the user-specified voltage compliance for the connected SMU.
	Voltage Bias	Maintains a selected constant-voltage state at the terminal, subject to a user-specified current compliance of the connected SMU.
Sweep	Current Sweep	Increments a series of current values or voltage values at a rate that is determined by the Timing and Speed settings in the ITM Definition tab. Generates parametric curve data that is recorded in the Sheet tab Data worksheet for the ITM and can be plotted in the ITM Graph tab.
	Voltage Sweep	
List sweep	Current List Sweep	Steps through a list of <i>user-specified</i> current values or voltage values, at a rate that is determined by the Timing and Speed settings in the ITM Definition tab. Generates parametric data that is recorded in the ITM Sheet tab Data worksheet and can be plotted in the ITM Graph tab, if appropriate.
	Voltage List Sweep	
		<div style="display: flex; justify-content: space-around;"> <div style="text-align: center;"> <p>Linear sweep</p> </div> <div style="text-align: center;"> <p>Log sweep</p> </div> </div>
		<div style="display: flex; justify-content: space-around;"> <div style="text-align: center;"> <p>Arbitrary function</p> </div> <div style="text-align: center;"> <p>Linear sweep of pulses</p> </div> </div>

Table 2-2 (cont.)

Forcing function summary

General type	Name	Description and graphical illustrations
Step	Current Step	Increments a current or voltage to two or more levels, each of which is held constant during the progress of a Current Sweep, a Voltage Sweep, a Current List Sweep, or a Voltage List Sweep at another terminal. For each Current Step or Voltage Step level, parametric curve data is recorded in the ITM Sheet tab Data worksheet. The combined data can be plotted in the ITM Graph tab, resulting in a series (family) of curves.
	Voltage Step	



For forcing-function details, refer in Section 6 of the Reference Manual to subsections entitled “Understanding and configuring the <ForcingFunctionName> function parameters area.”

Use the Definition tab to configure ITM parameters

NOTE *This section describes parameter configuration of a library ITM, in which connections and test modes are preconfigured. For discussions of general ITM configuration, including creation of new ITMs or customization of existing ITMs, refer in Section 6 of the Reference Manual to “Configuring the Project Plan ITMs.”*

After inserting library ITMs into your Project, configure the setup for each ITM as described in the subsections that follow — in the order in which they appear.

Match the physical and virtual connections

Do the following:

1. In the Project Navigator double-click on the ITM that you wish to configure. The **Definition** tab of the ITM window opens by default (see example in [Figure 2-10](#) above).
2. In the **Definition**-tab, review the virtual connections for each device terminal, as listed in the *instrument object* for that terminal (see to [Figure 2-10](#)).

- Ensure that the physical device connections match the virtual (**Definition** tab) device connections. If necessary, shut down the instrumentation and correct the physical connections.

CAUTION Physical device-terminal connections must accurately match virtual connections to avoid bad test results and potential device damage.

Configure the forcing functions for each device terminal

With the **Definition** tab for the ITM open, do the following for *each* device terminal:

- On the instrument object for the terminal (Figure 2-10), click the **FORCE MEASURE** button. The corresponding Forcing Function/Measure Options window appears. The Forcing Functions/Measure Options window in Figure 2-11 illustrates typical window features.

Figure 2-11
Typical Forcing Functions/Measure Options window for an existing library ITM

For a **Linear sweep** or **step** **Start** is the voltage/current at the start of the sweep, **Stop** is the voltage/current at the end of the sweep, and **Step** is the voltage/current change between steps¹. **Data Points** — calculated automatically from the **Start**, **Stop**, and **Step** values — is disabled.

For a **Log** sweep, you specify the **Data Points** value. The **Step** value — calculated automatically — is disabled

Select the SMU range to be used when forcing the specified voltage or current. Select dynamically optimized range (**Auto**), single best range for entire sweep (**Best Fixed**), or manually specified numerical range.

Check to enable current measurement options, recording of current in the **Sheet** tab **Data** worksheet, and availability of current data for plotting in the **Graph** tab.

If desired enter a preferred data label for the current (in lieu of the default label).

Select dynamically optimized range (**Auto**), dynamically optimized range above a specified lower limit (**Limited Auto**), the one best range for entire sweep (**Best Fixed**), or manually specified numerical range.³

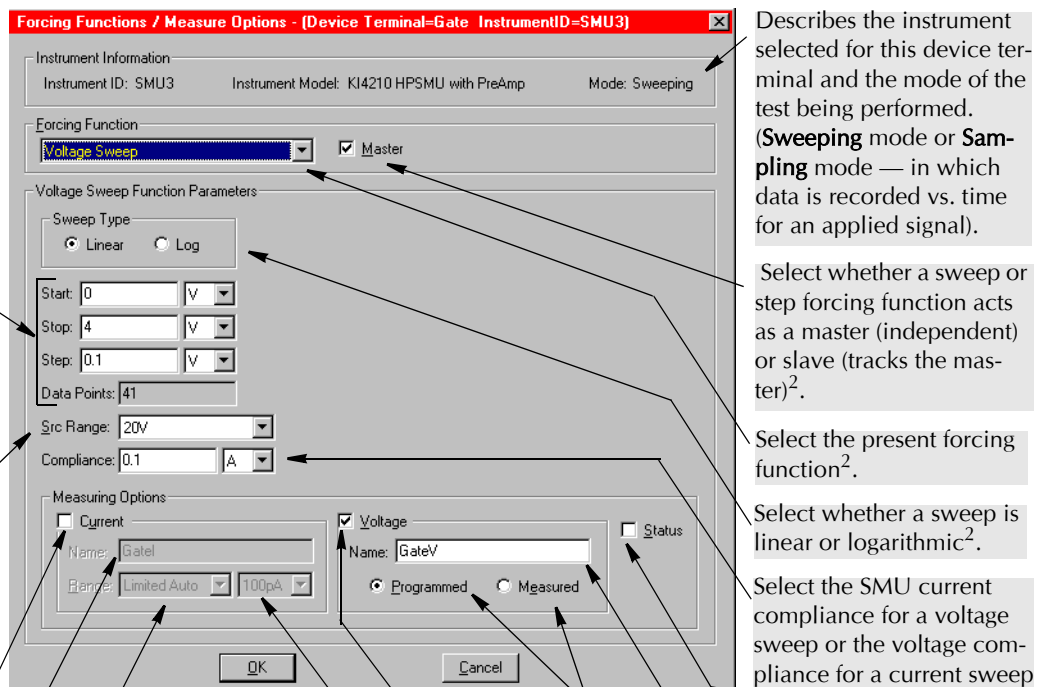
If you select **Limited Auto**, specify the limit here.³

Check to enable voltage measurement options, recording of voltage in the **Sheet** tab **Data** worksheet, and availability of voltage data for plotting in the **Graph** tab.

Programmed specifies logging of *as-configured* data values (e.g. calculated from **Start**, **Stop**, **Step**). **Measured** specifies logging of *as-measured* data values.⁴

If desired enter a preferred data label for the voltage (in lieu of the default label).

Check to cause KITE to log 32-bit measurement-status codes, in the **Data** worksheet, when the ITM executes.



Describes the instrument selected for this device terminal and the mode of the test being performed. (**Sweeping** mode or **Sampling** mode — in which data is recorded vs. time for an applied signal).

Select whether a sweep or step forcing function acts as a master (independent) or slave (tracks the master)².

Select the present forcing function².

Select whether a sweep is linear or logarithmic².

Select the SMU current compliance for a voltage sweep or the voltage compliance for a current sweep

¹In a List Sweep configuration window, you enter a list of discrete voltages or currents, instead of **Start**, **Stop**, and **Step** values. In a Current Bias or Voltage Bias configuration window, you enter a fixed **Level** value, instead of **Start**, **Stop**, and **Step** values.

²Do not change these parameters, unless you want to customize the ITM — which is beyond the scope of this QuickStart manual.

³If sweeping/stepping voltages If sweeping/stepping currents, replaced with **Programmed** and **Measured** buttons, as in right panel.

⁴If sweeping/stepping voltages. If sweeping/stepping currents, buttons replaced with **Range** settings similar to those in left panel.

2. Referring to the setting explanations in [Figure 2-11](#) above, configure the following types of parameters for the device terminal's forcing function, as appropriate:
 - **Linear** or **Log** for a Sweep-type forcing function.
 - The current or voltage value(s) to be forced:
 - **Level** for a static forcing function
 - **Start**, **Stop**, and **Step** for a Step or **Linear** Sweep forcing function
 - **Start**, **Stop**, and **Data Points** for a **Log** Sweep forcing function
 - **Data Points** value and list of **Amperes** or **Volts** values for a List Sweep
 - The default or desired **Src Range** and **Compliance**
 - The default or desired **Measuring Options**
3. Click on **OK**. The configuration for this device terminal takes effect and the Forcing Functions/Measure Options window closes.
4. Repeat steps 1 through 3 for the remaining device terminals.

Set up Formulator calculations, if desired

The **Formulator**, accessible from an ITM **Definition** tab, allows you to perform simple *in-test* calculations and complex *post-test* data calculations on ITM data.

The following operators and functions may be used for the *in-test*, real-time calculations:

- Operators: +, -, *, /, ^
- Functions: ABS, DELTA, DIFF, EXP, INTEG, LN, LOG, SQRT

A variety of additional functions may be used for *post-test* calculations.

For details on using the **Formulator**, refer in Section 6 of the 4200-SCS Reference Manual to “Configuring Formulator calculations.”

Save the ITM configuration

Click the **Save** button () in the *KITE* toolbar.

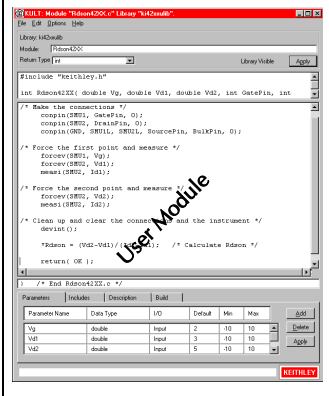
Defining and configuring the Project UTM's

Figure 2-12 below overviews the complete UTM-definition process. However, you need not perform the steps at the left side of Figure 2-12 unless you need a custom user library. The 4200-SCS provides several user libraries containing a variety of user modules.

Figure 2-12
UTM-creation overview

User libraries, either created and supplied by Keithley (as provided with the 4200-SCS) or custom-created, as shown here.

- Create a user module in the Keithley User Library Tool (KULT) by:
- 1) Opening a new or existing user library
 - 2) Opening a new or existing user module
 - 3) Programming/editing, specifying parameters, and saving the user module
 - 4) Compiling the user module



Add/update user modules into their specified new or existing user libraries, using the **KULT Build Library** menu command.

matrixulib
user library



ki42xxulib
user library

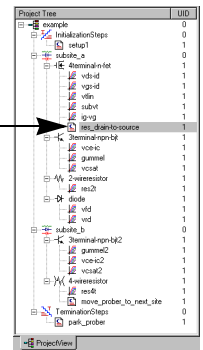
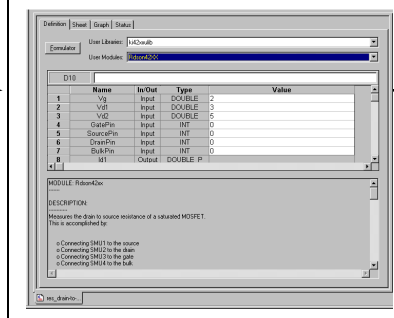


...

Winulib
user library



- Create executable UTM by:
- 1) connecting a UTM name to a user-library user module; and
 - 2) configuring the user-module input parameters.



Understand the UTM Definition tab

After inserting a name-only UTM into a project, the new UTM is defined using the UTM **Definition** tab—displayed by double-clicking on the UTM name in the Project Navigator. Figure 2-13 illustrates and explains the UTM **Definition** tab.

Figure 2-13
UTM Definition tab

Graph tab: Graphical test and analysis results.

Status tab: Test definition and configuration status.

User libraries combo box: Select the user library here that contains the desired module.

User modules combo box: Select the desired user module here for the UTM.

Sheet tab: Numerical test and analysis results and test settings.

Formulator: Mathematical test results analysis tool.

Output Values button: Click to export Output Values for this test into the Subsite Data sheet.

Parameter identity cells: Spreadsheet-like cells that list the test-module parameter names and data types, as specified in the user module.

Workspace window tab: You can quickly access a Project-component window that is active in the KITE workspace — several can be active simultaneously — by selecting its Workspace tab (Must be enabled. See “Specifying environmental preferences” in Section 6 of the Reference Manual.)

Documentation area: Displays important information about the user module.

Parameter entry cells: Enter test-parameter values in these spreadsheet-like cells.

Cell display edit box: Displays contents of selected cell. You can enter data here.

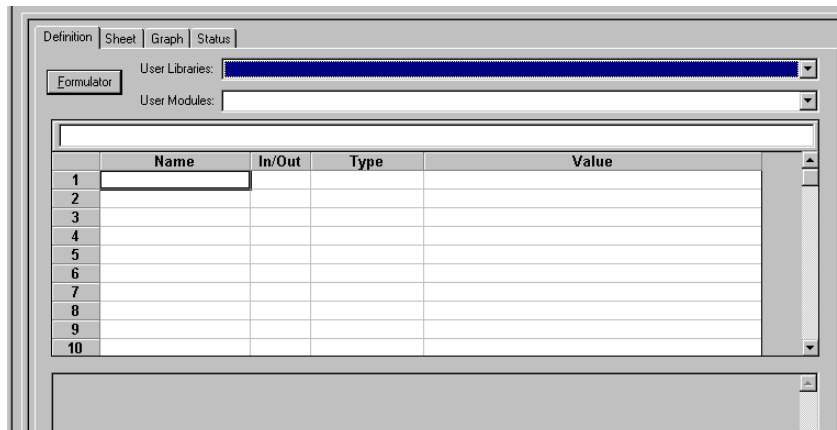
	Name	In/Out	Type	Value
1	OpenAll	Input	INT	1
2	TermIdStr1	Input	CHAR_P	SMU1
3	Pin1	Input	INT	3
4	TermIdStr2	Input	CHAR_P	SMU2
5	Pin2	Input	INT	4
6	TermIdStr3	Input	CHAR_P	SMU3
7	Pin3	Input	INT	5
8	TermIdStr4	Input	CHAR_P	SMU4
9	Pin4	Input	INT	0

Define UTMs using the UTM Definition tab

Define a UTM as follows:

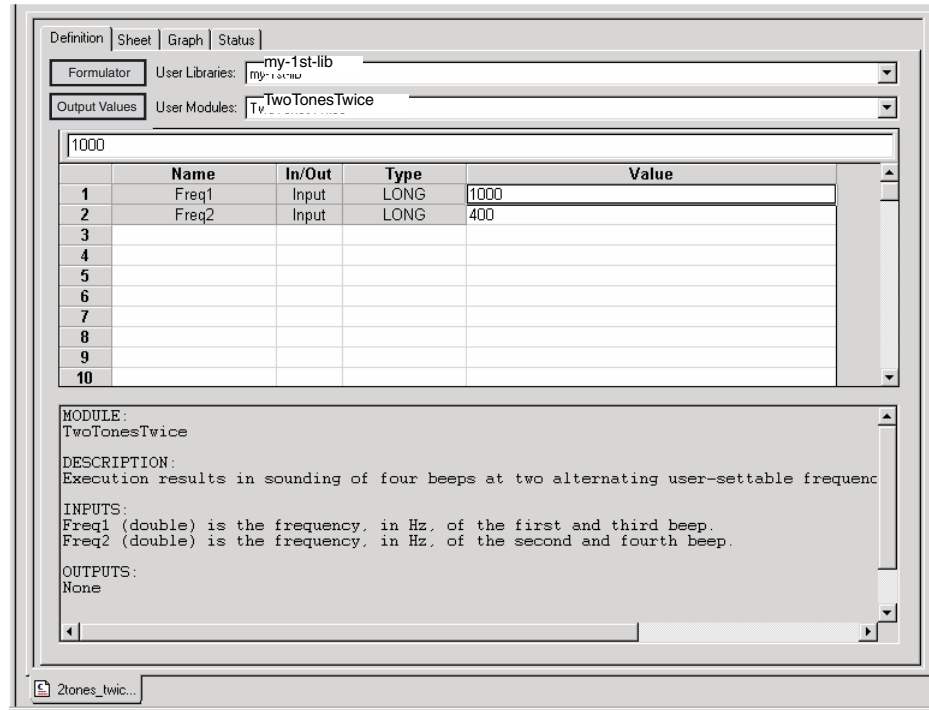
1. In the Project Navigator, double-click the name of the new UTM to be defined. A blank UTM Definition tab appears. See [Figure 2-14](#)


Figure 2-14.
Blank UTM Definition tab



- In the **User Libraries** scroll box of the UTM Definition tab, select the user library that contains the user module that you wish to test. In [Figure 2-15](#) below, **my-1st-lib** is selected.

Figure 2-15
Example of configured UTM tab



- In the **User Modules** scroll box of the UTM Definition tab, select the user module that you wish to test. The UTM displays the configuration parameters for the selected user module. In [Figure 2-15](#) above, **TwoTonesTwice** is selected as the user module. In the Documentation area, the module displays information about itself, as recorded when it was created.
- Accept the default parameter values for now. (You can change them later after you establish that the user module executes correctly.)
- Save the UTM and the project by clicking the **Save All** toolbar button ().
- Test the UTM before using it. Refer to the subsequent subsection “Executing a single test.”

Create custom user modules and user libraries, if necessary

If you need a custom user module for a UTM(s), you can either create a completely new module/library or customize a copy of one of the Keithley-supplied modules/libraries (Most can be modified.) A user module is a C-language function (subroutine) that 1) typically calls functions from the Keithley-supplied Linear Parametric Test Library (LPTLib) — as well as ANSI-C functions — and 2) is developed using the Keithley User Library Tool (*KULT*). A user library is a dynamic link library (DLL) of user modules that are compiled and linked using *KULT*.

This subsection provides the information to create basic user modules and user libraries. Refer also to Section 8 of the 4200-SCS Reference Manual, which describes use of *KULT* in detail.

Understanding the KULT interface

[Figure 2-16](#) below illustrates the *KULT* programming and definition interface

Figure 2-16.
KULT interface overview

File menu:

Used to: open and close libraries and modules; save, copy, and delete modules;

Edit menu:

Used to: cut, copy and paste; select all; undo and redo.

Options menu:

Used to: compile the active module; add/update the user module to the active user library; hide the module to make it unavailable to KITE

Library:

Displays the name of the active library

Module box:

Displays the name of the active module.

Return Type combo box:

Used to select the output data type from one of the following options: char, float, double, int, long, void.

Library Visible or **Library Hidden** display:

Indicates if library is available or unavailable to KITE. Visibility is controlled via the **Options** menu.

Apply button (one of two, both of which function identically):

Used to update active module to reflect additions and changes. Creates new active module when **Module** name is changed.

Module-parameter display area:

Displays—only—the includes, defines and function prototype for the module, to reflect entries in the **Parameters** entry tab and **Includes** entry tab areas.

Module code entry area:

Displays the C-code of the active module and, via its integral text editor, enables code development and editing.

Terminating brace area:

Shows terminating brace for the module code; automatically entered when you click either **Apply** button.

Parameters entry tab area:

Used to do the following for each module I/O parameter:

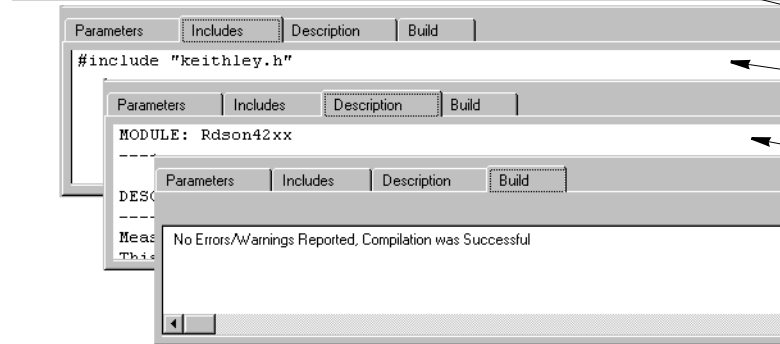
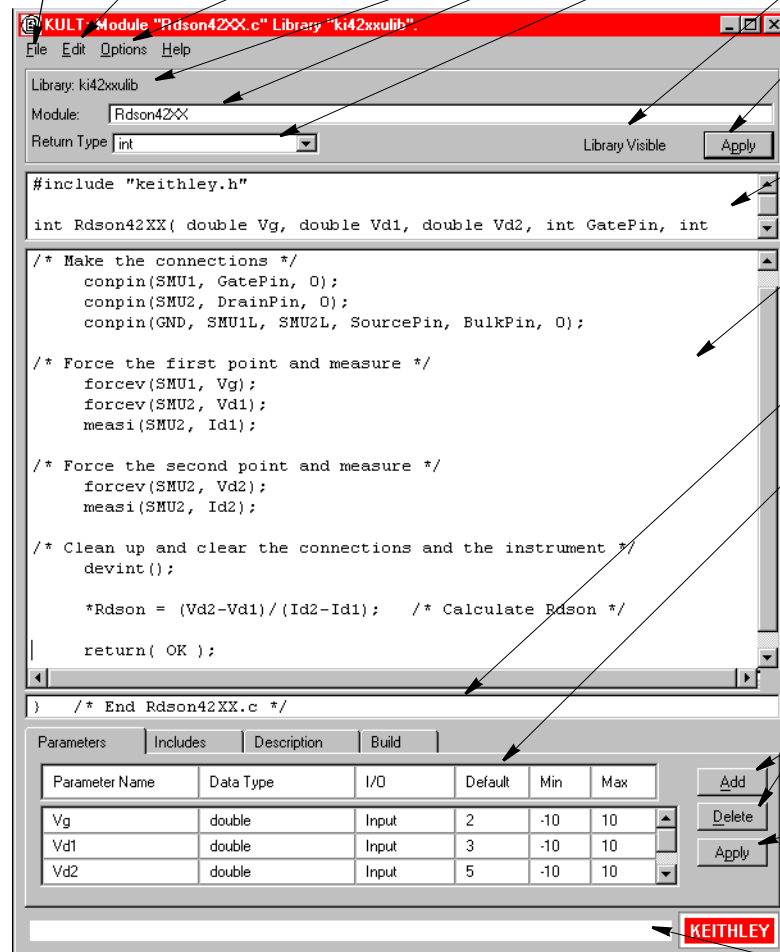
- Enter the parameter name.
- Select the parameter data type from a list of data types, data-pointer types, and array types [outputs must always be pointers (char *, float *, double *, etc., or arrays).
- Select whether the parameter is an input or output (only selectable for pointers and arrays; others always inputs). Optionally enter default, max, and min parameter values.

Add and **Delete** buttons:

Used to add or delete a selected parameter from **Parameters** entry tab area.

Apply button (one of two, both of which function identically):

Used to update active module to reflect additions and changes. Creates new active module when **Module** name is changed.



Status bar:

Displays description of window area at cursor

Includes entry tab area:

Used to enter the module's include and define statements.

Descriptions entry tab area:

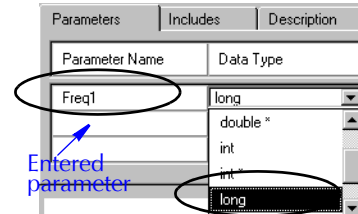
Used to document the active module.

Build tab area:

Displays status and error messages for the Compile and Library Build operations. A double-click on an error message highlights the trouble spot in the module code area.

Declare the parameters for the new module

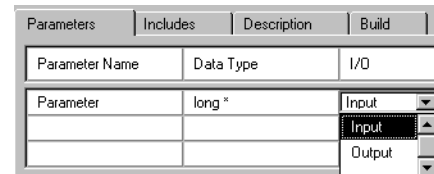
1. Enter one of the required parameters for the code as follows:
 - a. Click the **Parameters** tab.
 - b. Click the **Add** button at the right side of the **Parameters** tab area. (See the figure at right.)
 - c. Under **Parameter Name**, enter the first parameter name. (See the example for step d, below right.)
 - d. Enter the C data type for the parameter that you just entered, as follows (see the example at right):
 - Click the cell adjacent to the parameter, under **Data Type**. A pop-up menu displays the allowed data types.
 - Select a data type in the popup menu.



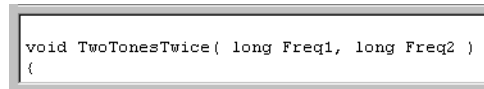
NOTE For an output parameter, only the following data types are acceptable: pointers (*char**, *float**, *double**, etc.) and arrays (*I_ARRAY_T*, *F_ARRAY_T*, or *D_ARRAY_T*).

2. Under **I/O**, specify that whether the parameter that you added in step 6 is an input parameter (the default) or an output parameter.

Note that if you did not specify a *pointer* or *array* data type under **Data Type**, you must accept the default entry — **Input**. However, if you specified a pointer or array data type under **Data Type**, clicking the corresponding **I/O** entry cell results in display of a scroll box that contains both **Input** and **Output** options. See at right.



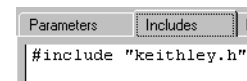
3. Under **Default**, **Minimum**, and **Maximum**, optionally enter default, minimum, and maximum values for the parameter — to simplify and limit the choices to the user.
4. Repeat steps 1 through 3 above for any additional input and output parameters that are needed for this user module.
5. Click **Apply** in the module-parameter display area. The module prototype now includes the declared parameters. See at right.



Enter the header files (#include, etc.) for the new module

Enter the header files as follows:

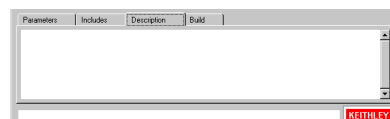
1. Click on the **Includes** tab at the bottom of the window. The **Includes** tab area appears, as shown at right.
2. Enter any *additional* header files that are needed by the user module. (Note that no additional header files are needed to customize any of the user libraries that come with the 4200-SCS.)
3. After all header files are entered, click **Apply**



Document the user module

Do the following:

1. Click the **Description** tab, which then displays fully. See at right.



- In the **Description** tab, enter any text that will be needed to adequately document the module in a UTM. See the example below for the `TwoTonesTwice` module.

CAUTION Do not use C-code comment designators (`/*`, `*/`, or `//`) in the **Description** tab area. These will cause errors when the user module is compiled. Also, do not place a period in the first column (the left-most position) of any line in the **Description** tab area. The UTM description area will not display text that follows a first-column period.

```

MODULE :
TwoTonesTwice

DESCRIPTION:
Execution results in sounding of four beeps at two alternating
user-settable frequencies. Each beeps sounds for 500ms.

INPUTS:
Freq1 (double) is the frequency, in Hz, of the first and third
beep.
Freq2 (double) is the frequency, in Hz, of the second and
fourth beep.

OUTPUTS:
None

RETURN VALUES:
None

```

Save the new user module

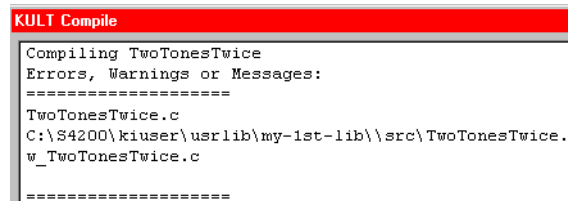
Save the module by clicking **Save Module** in the **File** menu.

Compile the new user module

Compile the module as follows:

- Click the **Build** tab at the bottom of the window. The **Build** tab area opens. After you compile a user module, the **Build** tab area displays either a confirmation that the module compiled successfully or displays one or more compile-error messages.
- In the **Options** menu, click **Compile**. The C source-code file compiles.

Also, the *KULT* Compile message box indicates compilation progress and, if problems occur, displays error messages. For example, when you *first* compile `TwoTonesTwice` — with its missing semicolon, you see the message shown at right.



```

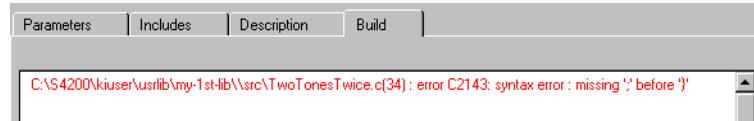
KULT Compile
Compiling TwoTonesTwice
Errors, Warnings or Messages:
=====
TwoTonesTwice.c
C:\S4200\kiuser\usr\lib\my-1st-lib\src\TwoTonesTwice.
w_TwoTonesTwice.c
=====

```

- When the *KULT* Compile message box closes—or, if there are error messages, when you click **OK**—the **Build** tab area displays one of the following:
 - If the compilation was successful, the following appears: **No Errors/Warnings Reported, Compilation was Successful.**
 - If the compilation was *unsuccessful*, the error message(s), if any, that was displayed in the *KULT* Compile message box also displays in the **Build** tab area.

NOTE *KULT reports true compilation errors in red — errors that prevent user module-compilation. However, KULT reports warnings in blue — for suspect code that does not prevent compilation (for example, declaration of an unused variable).*

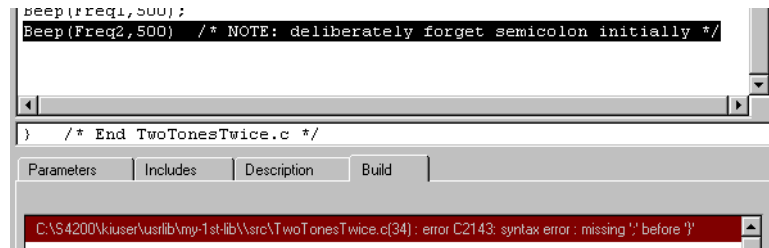
For example, after you first compile `TwoTonesTwice` and then click **OK** in the *KULT* Compile message box, the **Build** tab area reports the following:”



Find any code errors in the new user module

Do the following:

1. Click on the compilation-error message in the **Build** tab area, *KULT* does the following: a) highlights either the line of code where the error occurred or the next line, depending on how the compiler caught the error and b) highlights the error message. For `TwoTonesTwice`, the line that is missing the semicolon is highlighted, as shown below.



2. Correct the error. For `TwoTonesTwice`, the missing semicolon was added at the end of the code [`Beep (Freq2 , 500) ;`].
3. Save the user module. (Click **Save Module** in the **File** menu.)
4. Compile the user module again.
 - The *KULT* Compile message box should now display no error messages and disappear automatically.
 - The **Build** tab area should display the successful-compilation message. See example at right.



Build the user library that contains the new user module

After successfully compiling the user module, click **Options -> Build**. The following occurs:

- a. The user library builds.
- b. A Build Library message box indicates the build progress and, if linker problems occur, displays error messages.
- c. When the Build Library message box closes—or, if there are error messages when you click **OK**—the **Build** tab area displays one of the following:
 - If the compilation was successful, it displays **No Errors/ Warnings Reported, Library Build was Successful**.
 - If the compilation was unsuccessful, error messages that were displayed in the *KULT* Build Library message box window also display in the **Build** tab area (in red, only).

Find any build errors in the library

Find build errors using the information in the build-error message.

Check the user module

Check the user module by 1) creating a User Test Module (UTM) in *KITE*, as described previously in “Define UTMs using the UTM Definition tab” and then 2) executing the UTM, as described below in “Executing a single test at a single site.”

Executing the Project tests

NOTE *If KITE detects an above-normal temperature condition at any SMU, it protects system outputs by preventing or aborting a run and reporting the condition in the message area of KITE window. If the condition occurs when a run is attempted, KITE prohibits execution. If the condition occurs during a run, KITE aborts the run.*

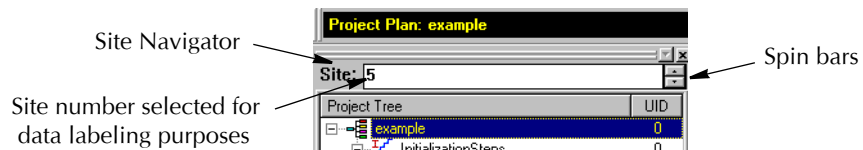
*You can abort any test by clicking the red **Abort Test/Plan** toolbar button.*

While a test is running, you can usually view ITM data dynamically, both numerically in a data sheet and—with appropriate configuration—graphically. (Refer to Section 3 of this manual.) New UTM data may be viewed only at the end of a test. The Message area of the KITE window displays start time, stop time, and total execution time.


Executing a single test at a single site

1. Select the ITM or UTM to be run by single-clicking it in the Project Navigator.
2. If your project can test more than one site, specify the site-number label to be used for the collected data, using the spin buttons (small arrows) of the Site Navigator — located at the top of the Project Navigator, [Figure 2-17](#). This number must match the *prober* site number.

Figure 2-17
Site Navigator for Example Project



For example, before running an ITM or UTM at site 5, set the Site Navigator to “5” and *physically move the prober to site 5*. (Note that the Site Navigator setting does not direct the prober in any way.) Then, each data file that is generated will be labeled with the correct site number. (Refer to site-labeling conventions in Section 3 of this manual under “Understanding the data files.”)

3. Click the green **Run Test/Plan** toolbar button (). The selected test runs.

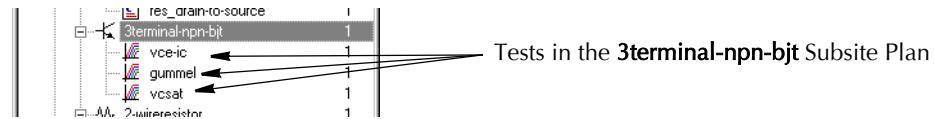
For detailed information, refer in Section 6 of the 4200-SCS Reference Manual to “‘Run’ execution of individual tests and test sequences.”

_RevA\QSBook\Art\Sec02

Executing a single test *sequence* at a single site

Running a test *sequence* causes all of the tests in a Device Plan or a Subsite Plan to execute in the order in which they are listed in the Project Navigator, from top-to-bottom.

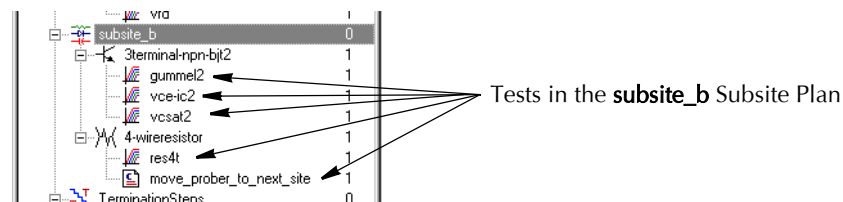
- For example, suppose that you run the **3terminal-npn-bjt** Device Plan, shown below.



Then then all tests in **3terminal-npn-bjt** execute in the following sequence:

vce-ic → **gummel** → **vcsat**

- Or, for example, suppose that you run the **subsite_b** Subsite Plan, shown below,



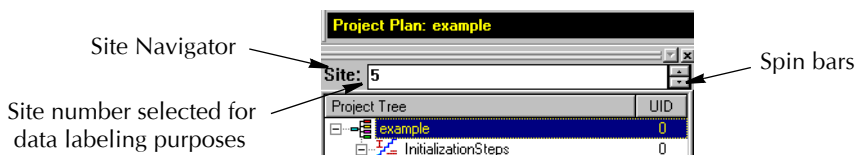
Then all tests in **subsite_b** execute in the sequence shown below:

gummel2 → **vce-ic2** → **vcsat2** → **res4t** → **move_prober_to_next_site**

To run a test sequence, do the following:

- Select the Device Plan or Subsite Plan to be run by single-clicking it in the Project Navigator.
- If your project can test more than one site, specify the site-number label to be used for the collected data, using the spin buttons (small arrows) of the Site Navigator — located at the top of the Project Navigator, [Figure 2-18](#). This number must match the present *prober* site number.

Figure 2-18
Site Navigator for example Project



For example, before running a test sequence at site 5, set the Site Navigator to “5” and *physically move the prober* to site 5. (Note that the Site Navigator setting does not direct the prober in any way.) Then, each data file that is generated will be labeled with the correct site number. (Refer to site-labeling conventions in Section 3 of this manual under “Understanding the data files.”)




- Click the green **Run Test/Plan** toolbar button (). The selected test sequence runs.

For detailed information, refer in Section 6 of the 4200-SCS Reference Manual to “‘Run’ execution of individual tests and test sequences.”

Executing *appended* tests and test sequences at a single site

With **Run** execution, described above, there is only one **Data** worksheet for each specific test. This **Data** worksheet contains the data from the last run of the test. Each *new run* updates the worksheet — i.e. it *overwrites the previous data*.

However, *KITE* also provides **Append** execution, which generates multiple worksheets for multiple runs of a specific test—in *addition to* the **Data** sheet generated by **Run** execution. Also, in the **Graph** tab, **Append**-data curves for a test append to (layer on top of) the **Run** data curves. You can apply the **Append** mode to a single test or to an entire Device Plan or Subsite Plan.

To run in the **Append** mode, start the test or test sequence by clicking the green-in-yellow **Append Data** toolbar button (), [instead of the standard green **Run Test/Plan** toolbar button ()]. Thereafter, each time that you press the **Append Data** toolbar button (), new results append to the existing data, generating a separate data sheet for each run.

For details, refer in Section 6 of the 4200-SCS Reference Manual to “Append execution of tests, test sequences, and Project Plans” and “Appending curves from multiple runs on a single graph.”

Executing an entire Project at a single site

When you run an entire Project, all tests in the Project execute. For example, if you run the **example** Project (see prior [Figure 2-2](#)), all nineteen Project components execute in order.

To run an entire project, do the following:


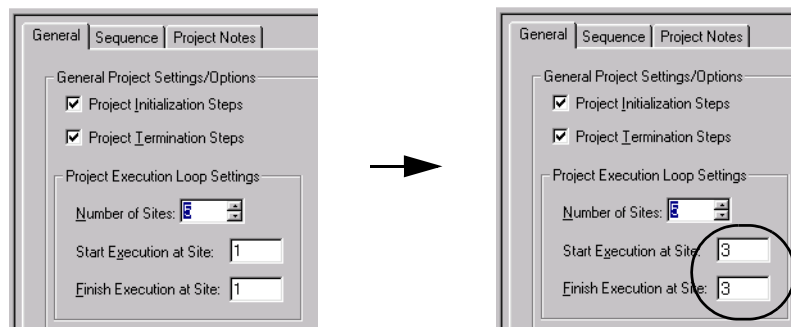

1. Double click on the Project name at the top of the Project Navigator “tree.” See at right.
 
2. In the project window, set *both* the **Start Execution at Site** and **Finish Execution at Site** values to the number of the site that you want to test. For example, when testing site 3, set both of these values to 3. See [Figure 2-19](#).

Figure 2-19
Setting the site number in the Project window.



3. Physically move the prober to the site that you specified in step 2.
4. Click the green Run Test/Plan toolbar button (). The Project tests run in the order in which they are listed in the Project Navigator, from top to bottom.

As each individual test runs, the test name appears in the Test/Plan Indicator box, as illustrated at right.

Interactive Test Module: vcsat#1@3

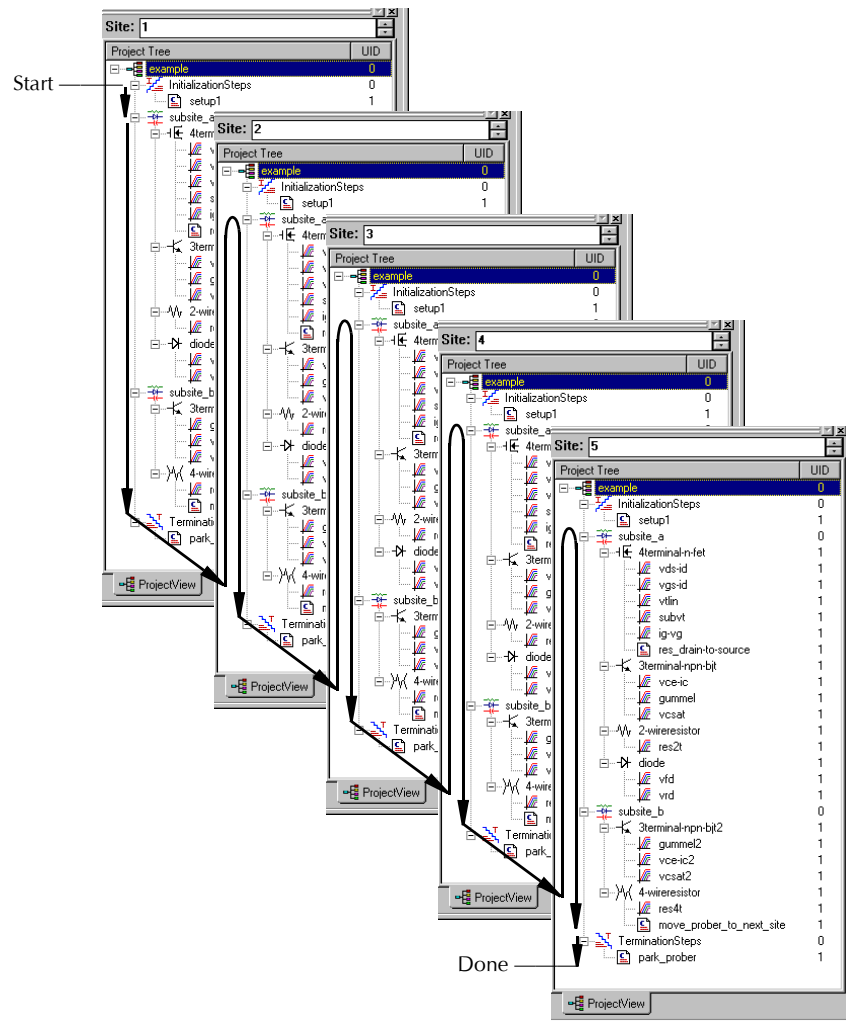
With an appropriate ITM window open in the *KITE* workspace, you can view the ITM data being placed in its data sheet or being graphed.

Refer also to “‘Run’ execution of Project Plans,” in Section 6 of the Reference Manual.

Executing an entire Project at multiple sites

For multi-site Project execution, all tests in the entire Project are repeated for a specified series of wafer sites. For example, [Figure 2-20](#) shows the test sequence for the **example** Project, when it is configured to test sites 1 through 5. After the user positions the probe at site 1, he/she starts execution. Then, *KITE* first executes the **InitializationSteps**, followed by the tests in the two Subsite Plans. Then the **move probe** UTM initiates a pulse that tells the *separately programmed* probe to move to site 2, where the **InitializationSteps**, and the two Subsite Plans are executed again. This process repeats for sites 3, 4, and 5. At site 5, after the second Subsite Plan is finished, the **TerminationSteps** park the probe.

Figure 2-20
Multi-site test sequence



NOTE The steps illustrated in [Figure 2-20](#) and the steps that follow assume that the 4200 SCS is connected to a semiautomatic probe and the Project contains the appropriate move steps.

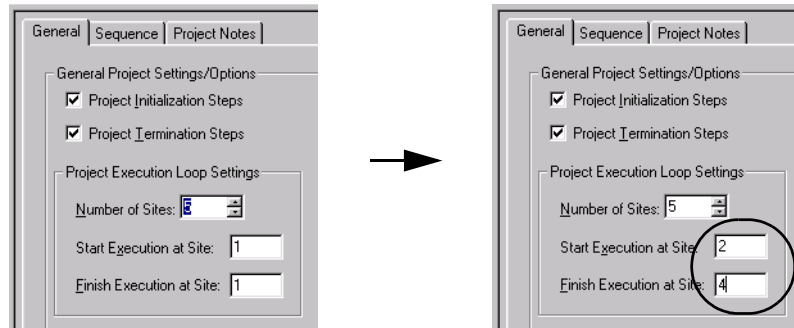
To run an entire project at multiple sites, do the following:

1. Double click on the Project name at the top of the Project Navigator “tree.” See at right. The project window opens. (See step 2.)



- In the project window, set the **Start Execution at Site** value to the lowest-numbered site that you want to test and set the **Finish Execution at Site** value the number of the last site that you want to test. For example, when testing sites 2 through 4, set the **Start Execution at Site** to **2** and **Finish Execution at Site** to **4**. See [Figure 2-21](#).

Figure 2-21
Setting the site numbers in the Project window




CAUTION In the Project window, do not change the settings on the **Project Initialization Steps** and/or **Project Termination Steps** checkboxes. They are to be used only when building or modifying a Project. Typically, UTMs under **InitializationSteps** and **TerminationSteps** in the Project perform such tasks as external instrument initialization and prober setup and parking. Unchecking **Project Initialization Steps** and/or **Project Termination Steps** checkboxes, and then clicking **Apply**, deletes the UTMs. Checking these checkboxes does not add UTMs.

- Physically move the prober to the first site (the **Start Execution at Site** site number) that you specified in step 2.
- Program the prober so that, when the 4200 emits move signals, it moves to sites and subsites in the site sequence that is specified in step 2 and the subsite sequence that is specified in the Project.

Therefore, for the **example**-Project setup illustrated in step 2, you would program the prober to respond to Project move signals in the following sequence, *after being manually positioned at Site 2*:

subsite_a -> **subsite_b** -> **Site 3** -> **subsite_a** -> **subsite_b** -> **Site 4** -> **subsite_a** ->
subsite_b -> Parked position

- Click the green Run Test/Plan toolbar button (). KITE runs the Project tests at the first site (the **Start Execution at Site** site), in the order in which they are listed in the Project Navigator. Then KITE tests the remaining Project sites, as illustrated in [Figure 2-20](#).

As each individual test runs, the test name and site number appears in the Test/Plan Indicator box, as illustrated at right.

Interactive Test Module: vcsat#1@3

With an appropriate ITM window open in the *KITE* workspace, you can view the ITM data being placed in its data sheet or being graphed.

Refer also to “Run’ execution of Project Plans,” in Section 6 of the Reference Manual.

Repeating a test

An individual test (ITM or UTM) can be run continuously by using the **Repeat Test Execution** button to start the test. The test does not stop after it is run the first time. Execution continuously loops back to the beginning to keep repeating the test.

Use the **Abort Test/Plan** button to stop the test. When the button is clicked, the test will stop immediately. The buttons to start repeat test execution and abort the test are shown as shown in [Figure 2-22](#).

Figure 2-22
Repeating a test



Test data – Additional sets of data are NOT generated for repeated tests. When the test repeats, the spreadsheet data for the last test is cleared. A graph will continuously update to reflect the data in the spreadsheet.

When the repeated test is aborted, it will stop immediately. Data for the spreadsheet and graph will be collected up to the point where the test was aborted.

NOTE *For more information on **Repeat**, see [Reference Section 6, “Repeating a test,”](#) page 6-163.*

Subsite cycling overview

By using **Cycle Subsite**, the selected (and enabled) Subsite Plan can be repeated a specified number times (up to 128). The following brief overview of Subsite Cycling covers the Cycle Mode and the Stress/Measure Mode, which is used for stress testing.

The Subsite Plan window is used to configure subsite cycling. Collected test data and graphs are also accessed from this window. The Subsite Plan window is opened by double-clicking the Subsite Plan in the Project Navigator.

NOTE *Detailed information on Subsite Cycling is provided in [Reference Section 6, “Subsite cycling,”](#) page 6-308.*

Subsite Data sheet and Graph – Data for subsite cycling is placed in the Subsite Data sheet, which is displayed by clicking the **Subsite Data** tab in the Subsite Plan window. Graphs for the collected data are viewed in the **Subsite Graph** tab.

The measured readings listed in this data sheet are Output Values. An Output Value is an imported measurement from an individual test in the Subsite Plan. An Output Value is added to the Subsite Data sheet by importing it from the ITM or UTM. See [“Output Values,”](#) page 2-33 for details.

Cycle Mode

In the **Cycle Mode**, the Subsite Plan is repeated a specified number of times. For each individual test in the Subsite Plan, data will be acquired for each subsite cycle. For example, if the subsite is cycled five times, there will be five sets of data (and graphs) for each test.

Cycle Mode configuration – The Cycle Mode is configured from the **Subsite Setup** tab of the Subsite Plan window. In the Subsite Plan window, click the **Subsite Setup** tab. The four steps to configure the Cycle Mode are shown in [Figure 2-23](#).

Start subsite cycling – With the Subsite Plan selected (and enabled) in the Project Navigator, click the **Run Test/Plan Cycle Subsites** button (see [Figure 2-24](#)) to start subsite cycling.

Figure 2-23
Cycle mode configuration

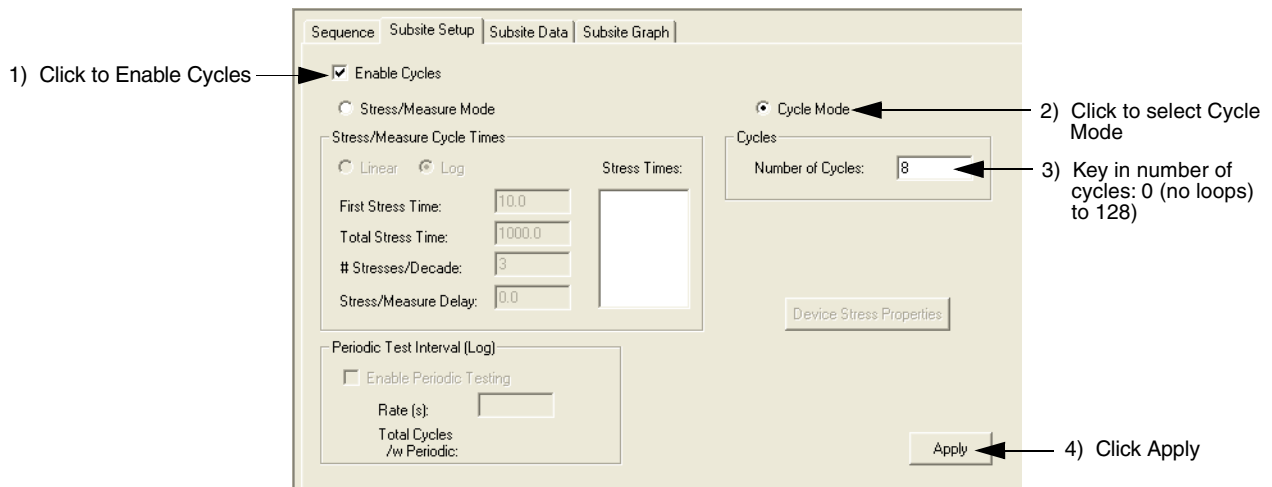
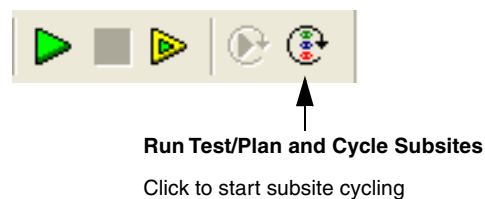


Figure 2-24
Start subsite cycling



Stress/Measure Mode (HCI stress-measure testing)

The Stress/Measure Mode uses HCI (Hot Carrier Injection) stressing of the devices in the Subsite Plan. Configuration for HCI stressing includes setting the stress time for each stress cycle, and the voltage or current stresses for the devices of the Subsite Plan.

When subsite cycling is started, the first pass through the Subsite Plan is a pre-stress cycle. Tests are run normally with no stressing. At the start of the next cycle, the configured stress (voltage or current) will be applied to all devices. After the stress time period expires, the stress is removed and enabled tests will then be run. Each additional stress cycle operates in the same manner. That is, the stress is applied for the specified stress time, then all the enabled tests are run.

Stress times configuration – Stress times are configured from the **Subsite Setup** tab of the Subsite Plan window. In the Project Navigator, double-click the Subsite Plan to display the Subsite Plan window. In the Subsite Plan window, click the **Subsite Setup** tab. The eight basic steps to configure stress times are shown in [Figure 2-25](#). After performing Step 8, refer to [Figure 2-26](#) to configure the Device Stress Properties.

Device Stress Properties – This window (shown in [Figure 2-26](#)) is opened by clicking the **Device Stress Properties** button in the in the Subsite Setup tab (Step 8 in [Figure 2-25](#)). From this window, stress voltages or currents and limits are set, and matrix connection pin assignments are set for each device in the Subsite Plan.

Start subsite cycling – With the Subsite Plan selected in the Project Navigator, click the **Run Test/Plan Cycle Subsites** button (see [Figure 2-24](#)) to start subsite cycling.

Figure 2-25
Stress/Measure Mode – log cycle times setup

1) Click to Enable Cycles

2) Click to select Stress/Measure Mode

3) Click to select Log cycle times

4) Enter stress times (in secs) for the first stress cycle and the total stress time for all cycles

5) Enter number of stresses per log decade

6) If desired, enter a delay that occurs after each stress period to allow pre-test settling for each device

7) Click Apply

8) Click to display the Device Stress Properties window for the first device. See Figure 2-26 for setup

If desired, enable (✓) periodic testing and set the rate. At each interval, as dictated by the rate, stressing is interrupted to perform the tests.

The Stress Times are automatically calculated based on the user-entered Cycle Times data.

Figure 2-26

Device Stress Properties – Setup steps for first device in Subsite Plan

1) Select the wafer site number.

2) Select Voltage Stress or Current Stress and then enter the stress values (V or I) and limit values (I or V).

3) Assign connection pin numbers for this device.

4) Degradation targets – Lists the tests and "Output Values" for this device. Targets can be enabled (✓) and the Target Values can be set (in %). Click to enable or disable all Targets. See "Degradation targets".

5) Use the pull-down menus to control Stress Measurements. Options include:
Do Not Measure
First Stress Only
Every Stress Cycle

6) For a multi-device Subsite Plan, click **Next Device** to display the stress properties window for the next device. Clicking **Prev Device** selects the previous device.

7) Repeat steps 2 through 6 for all devices in the Subsite Plan.

8) Repeat steps 1 through 7 to configure the Device Stress Properties for another site.

9) Click to check SMU resources and connections for the active (displayed) site. Resource Status will indicate if enough SMUs are present. Connections status will report any problems with matrix connections.

10) When finished setting the stress properties for all devices and all sites, click **OK**.

11) In the Subsite Plan tab, (see Figure 2-25), click **Apply** to apply and save the settings made in the Device Stress Properties window.

See "Clear, Copy and Paste".

Click to cancel all change and close window.

Output Values

For subsite cycling, output values from ITMs and UTMs can be exported into the Subsite Data sheet. Each time a subsite is cycled, the measurements for the output values are placed in the Subsite Data sheet. If for example, the subsite is cycled five times, there will be five measured readings for each Output Value.

Exporting Output Values – In the Project Navigator, double-click the ITM or UTM. Referring to Figure 2-10 (for an ITM) or Figure 2-13 (for a UTM), click the **Output Values** button. An **ITM Output Values** window is shown in Figure 2-27). The window for UTM Output Values is similar. The two steps to export Output Values are shown in the drawing.

Degradation targets

Post-stress Output Value readings are compared to the first cycle pre-stress readings. The % Change between the pre-stress and post-stress readings are placed in the Subsite Data sheet.

An Output Value can be enabled (√) as a Target and assigned a Target Value (in %). When all Targets for a device are reached, then that device will no longer be tested. Subsequent cycles will bypass the device tests that reached all its Targets. The Subsite Plan will stop when all targets are reached or the last subsite cycle is completed.

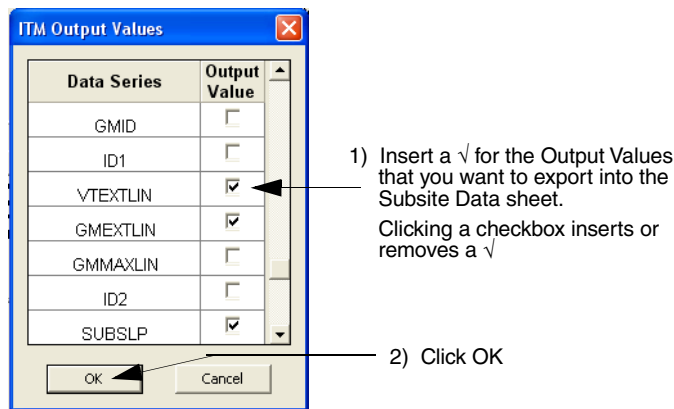
Clear, Copy and Paste

Clear – Clicking the **Clear** button clears all stress properties data for the displayed device. It sets all voltage and current values to zero, sets device pin number assignments to zero, sets Stress Measurements to “Do Not Measure”, and disables all Targets (clears Target % Values).

Copy and Paste – Copy and Paste allow properties settings for one device to be copied and pasted into the properties window for a different device. It can also be used to copy and paste settings into a different site. After the **Copy** operation, select the desired site/device and click **Paste**.

Figure 2-27

Exporting ITM Output Values to the Subsite Data sheet



Subsite Data sheet – Readings for Output Values from ITMs and UTMs are placed in the Subsite Data sheet. In the Project Navigator double-click the Subsite Plan to open it in the workspace. Click the **Subsite Data** tab to display the data sheet. Figure 2-28 shows an example of the Subsite Data sheet for the Stress/Measure Mode. For every subsite cycle (first column), the following data for every Output Value reading are included:

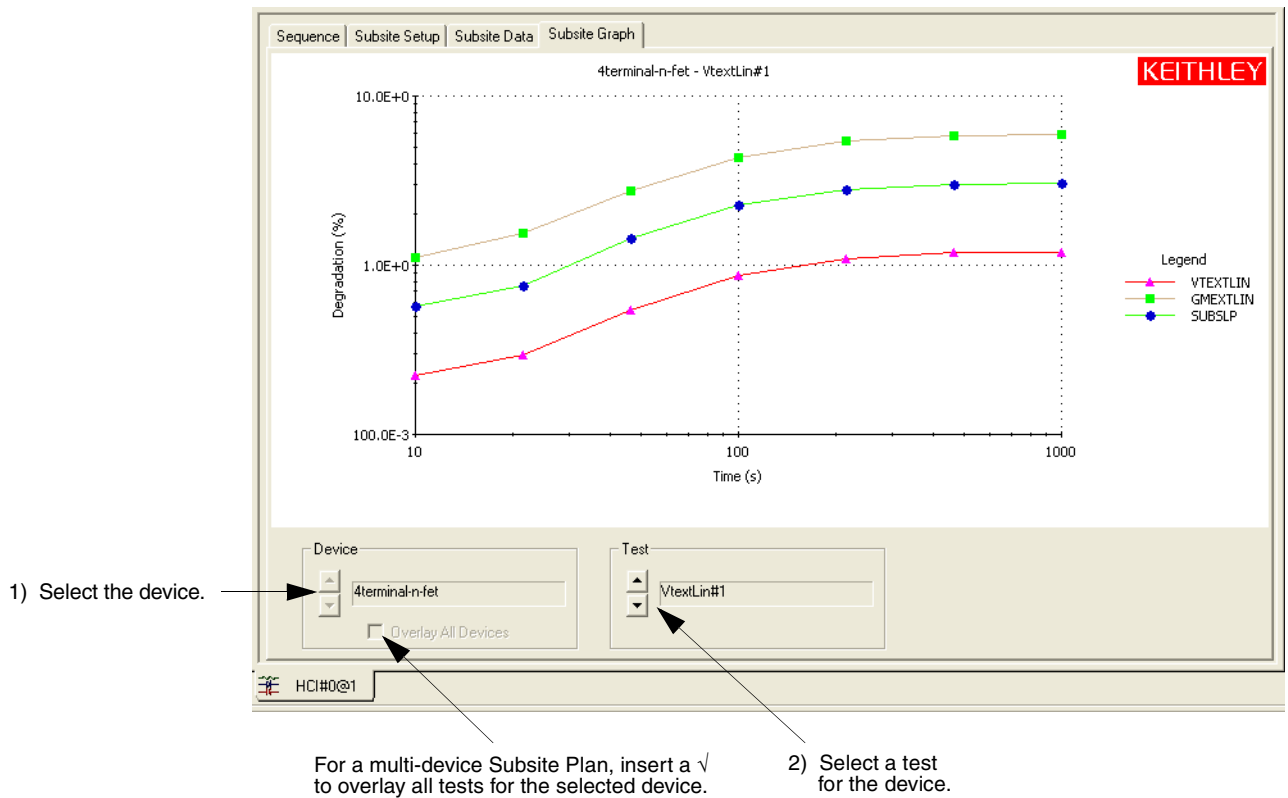
- Specified stress time.
- Measured reading for the Output Value.
- % Change – Reading variance from the first, pre-stress measured reading.
- Target Value – This is the specified Target % Value. If the target is not enabled, the target value will be 0.0.

Figure 2-28
Example Subsite Data sheet for the Stress/Measure Mode

	A	B	C	D	E	F	G	H	I	J	T
1	Cycle	Stress	Id#1	% Change	Target	Id#1	% Change	Target	Id#1	% Change	T
2	Index	Time	IDOFF	IDOFF	Value	IDLIN	IDLIN	Value	IDSAT	IDSAT	V
3	1	0.00	291.1666E-15		0.0	2.2350E-3		0.0	2.9236E-3		
4	2	10.00	82.2013E-15	71.8		2.2278E-3	0.3		2.9278E-3	0.1	
5	3	21.54	75.8693E-15	73.9		2.2254E-3	0.4		2.9291E-3	0.2	
6	4	46.42	86.3425E-15	70.3		2.2171E-3	0.8		2.9338E-3	0.3	
7	5	100.00	154.8986E-15	46.8		2.2062E-3	1.3		2.9395E-3	0.5	
8	6	215.44	244.7654E-15	15.9		2.1986E-3	1.6		2.9432E-3	0.7	
9	7	464.16	255.5181E-15	12.2		2.1960E-3	1.7		2.9444E-3	0.7	
10	8	1000.00	265.6278E-15	8.8		2.1959E-3	1.8		2.9446E-3	0.7	

Subsite Graph – The Output Values for each test can be graphed as shown in Figure 2-28.

Figure 2-29
Example Subsite Graph for the Stress/Measure Mode



For a multi-device Subsite Plan, insert a \checkmark to overlay all tests for the selected device.

3

Viewing test results

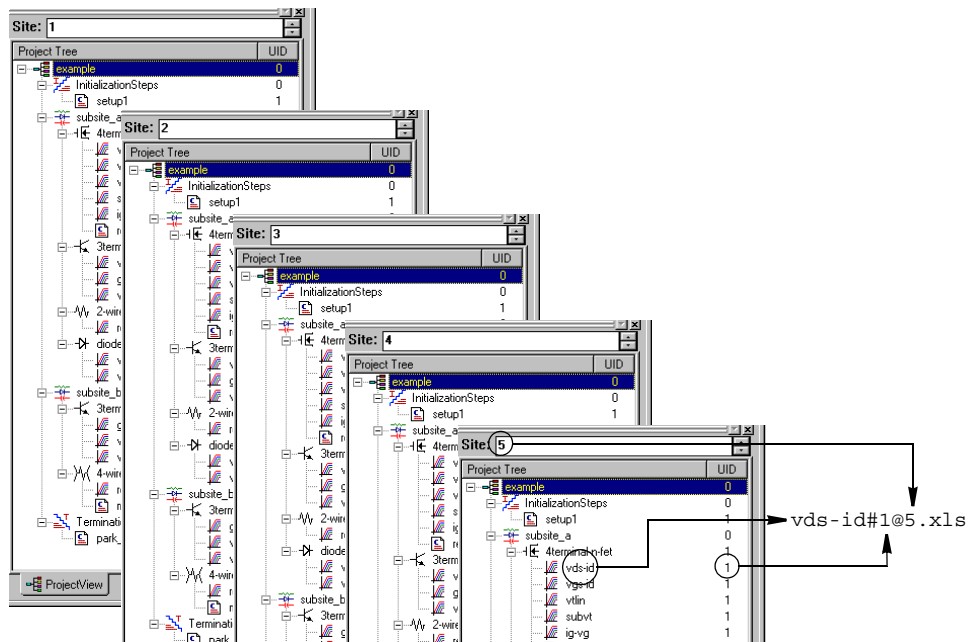
Understanding the data files

Data file naming

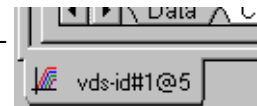
If the Workbook environment mode is enabled (per “Specifying environment preferences,” in Section 6 of the Reference Manual), the Workspace window tab at the bottom of an ITM or UTM window indicates, in the following order: 1) the name of the ITM or UTM; 2) its **UID** (Unique Identifier) number; and 3) the site number where the data was collected. Consider, for example, data naming for the test that is circled in [Figure 3-1](#).

Figure 3-1

Workspace-window tab name and data file name format



The Workspace *window tab* at the bottom of **Sheet** and **Graph** tabs for this test is labeled **vds-id#1@5**. The “vds-id” is the ITM name, #1 indicates a level-1 **UID** (Unique Identifier) number, and @5 indicates that the data was collected at site 5. See at right.



The data *filename* for a test is the same as the Workspace window tab name for the test, except for the addition of an `.xls` file extension (Microsoft Excel-compatible). Therefore, the data filename for the test that is highlighted in [Figure 3-1](#) is `vds-id#1@5.xls`. If the Project in [Figure 3-1](#) contained second and third instances of “vds-id,” their respective UID numbers would be 2 and 3, and their site 5 data files labels would be `vds-id#2@5.xls` and `vds-id#3@5.xls`.

Data file location

By default, test data files are stored on the 4200-SCS hard disk in the following directory:

- `C:\S4200\kiuser\Projects\\tests\data`

For example, the following path accesses the “vds-id” test data file for the **example** project:

- `C:\S4200\kiuser\Projects\example\tests\data\vds-id#1@1.xls`

For more information on test-data file structure, refer to “Tests subdirectory,” in Section 6 of the 4200-SCS Reference Manual.

Viewing test results numerically via the Sheet tab Data worksheet

The **Sheet** tab, accessible from an ITM or UTM window, numerically displays data for the ITM or UTM on a Microsoft Excel-compatible **Data** worksheet. [Figure 3-2](#) below shows a **Sheet** tab **Data** worksheet containing data generated by the “vds-id” ITM.

Figure 3-2
Sheet tab Data worksheet

Parameter names. The repeated parameter names in this case [for example DrainVolt(1), Drain Volt(2), ... etc.] correspond to drain-voltage Sweeps at gate Step-voltage 1, gate Step-voltage 2, ... etc.

Data, in this case for multiple drain-voltage Sweeps at different gate-voltage Steps. (Refer to “Sweep” and “Step” in Section 2, Table 2-2.)

Workspace window tab:

You can quickly access a Project-component window that is active in the KITE workspace — several can be active simultaneously — by selecting its Workspace tab (Must be enabled. See “Specifying environmental preferences” in Section 6 of the Reference Manual.)

	A	B	C	D	E	F	G
1	DrainCurrent	DrainVolt(1)	GateVolt(1)	DrainCurrent	DrainVolt(2)	GateVolt(2)	DrainCurrent
2	2.69733E-11	0.00000E-01	2.00000E+00	2.35055E-11	0.00000E-01	3.00000E+00	2.48973E-11
3	8.59179E-04	1.00000E-01	2.00000E+00	1.25070E-03	1.00000E-01	3.00000E+00	1.56022E-03
4	1.65599E-03	2.00000E-01	2.00000E+00	2.45347E-03	2.00000E-01	3.00000E+00	3.07960E-03
5	2.39495E-03	3.00000E-01	2.00000E+00	3.61199E-03	3.00000E-01	3.00000E+00	4.56253E-03
6	3.06948E-03	4.00000E-01	2.00000E+00	4.71752E-03	4.00000E-01	3.00000E+00	5.99838E-03
7	3.68147E-03	5.00000E-01	2.00000E+00	5.77335E-03	5.00000E-01	3.00000E+00	7.39149E-03
8	4.23041E-03	6.00000E-01	2.00000E+00	6.77790E-03	6.00000E-01	3.00000E+00	8.73960E-03
9	4.71815E-03	7.00000E-01	2.00000E+00	7.73332E-03	7.00000E-01	3.00000E+00	1.00459E-02
10	5.14285E-03	8.00000E-01	2.00000E+00	8.63258E-03	8.00000E-01	3.00000E+00	1.12998E-02
11	5.50827E-03	9.00000E-01	2.00000E+00	9.47832E-03	9.00000E-01	3.00000E+00	1.25073E-02
12	5.81830E-03	1.00000E+00	2.00000E+00	1.02721E-02	1.00000E+00	3.00000E+00	1.36691E-02
13	6.07518E-03	1.10000E+00	2.00000E+00	1.10084E-02	1.10000E+00	3.00000E+00	1.47774E-02
14	6.28476E-03	1.20000E+00	2.00000E+00	1.16913E-02	1.20000E+00	3.00000E+00	1.58351E-02
15	6.45256E-03	1.30000E+00	2.00000E+00	1.23199E-02	1.30000E+00	3.00000E+00	1.68412E-02
16	6.58471E-03	1.40000E+00	2.00000E+00	1.28972E-02	1.40000E+00	3.00000E+00	1.77992E-02
17	6.68605E-03	1.50000E+00	2.00000E+00	1.34201E-02	1.50000E+00	3.00000E+00	1.87017E-02
18	6.76269E-03	1.60000E+00	2.00000E+00	1.38916E-02	1.60000E+00	3.00000E+00	1.95522E-02
19	6.81990E-03	1.70000E+00	2.00000E+00	1.43148E-02	1.70000E+00	3.00000E+00	2.03532E-02
20	6.86246E-03	1.80000E+00	2.00000E+00	1.46891E-02	1.80000E+00	3.00000E+00	2.10999E-02
21	6.89466E-03	1.90000E+00	2.00000E+00	1.50178E-02	1.90000E+00	3.00000E+00	2.17957E-02
22	6.91982E-03	2.00000E+00	2.00000E+00	1.53037E-02	2.00000E+00	3.00000E+00	2.24406E-02
23	6.94024E-03	2.10000E+00	2.00000E+00	1.55508E-02	2.10000E+00	3.00000E+00	2.30381E-02
24	6.95734E-03	2.20000E+00	2.00000E+00	1.57602E-02	2.20000E+00	3.00000E+00	2.35848E-02
25	6.97220E-03	2.30000E+00	2.00000E+00	1.59371E-02	2.30000E+00	3.00000E+00	2.40841E-02

Note that the Workspace window tab at the bottom of the **Sheet** tab **Data** worksheet identifies the ITM that generated the data. Refer to the later subsection, “Understanding data-file naming conventions.” For detailed information about the **Sheet** tab, refer in Section 6 of the Reference Manual to “Displaying and analyzing data using the Sheet tab.”

To access the **Data** worksheet for a test, do the following:

1. If the test ran at multiple sites, set the Site Navigator to the number of the site where the data was generated
2. Double click on the test in the Project Navigator. The corresponding **Definition** tab opens.
3. Click on the **Sheet** tab. The Data sheet appears.

While an ITM (only) runs, you can access its **Data** work sheet and watch the data populate it.

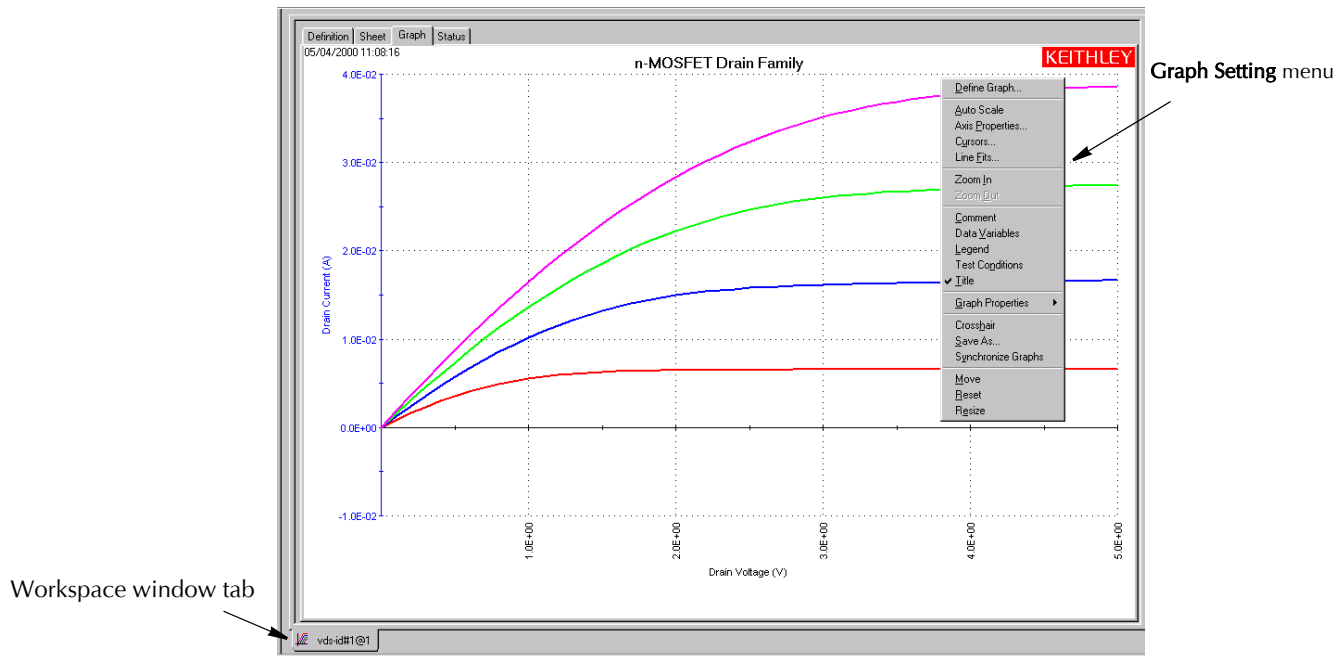
For details on viewing test data, refer to [Reference Section 6, “Displaying and analyzing data using the Sheet tab,”](#) page 6-165.

Viewing test results graphically via the Graph tab

The **Graph** tab, accessible from an ITM or UTM window, graphically displays data from the **Sheet** tab in a format that you specify. While an ITM is running, you can watch the data populate the graph.

While the **Graph** tab is displayed, a **Graph Setting** *pop-up* menu appears when you right-click on the **Graph** tab or select **Tools** → **Graph Settings**. The pop-up menu accesses plot configuration parameters. The **Graph** tab of [Figure 3-3](#) below plots the **Sheet** tab data of [Figure 3-2](#) above and shows the **Graph Setting** pop-up menu.

Figure 3-3
Graph tab example



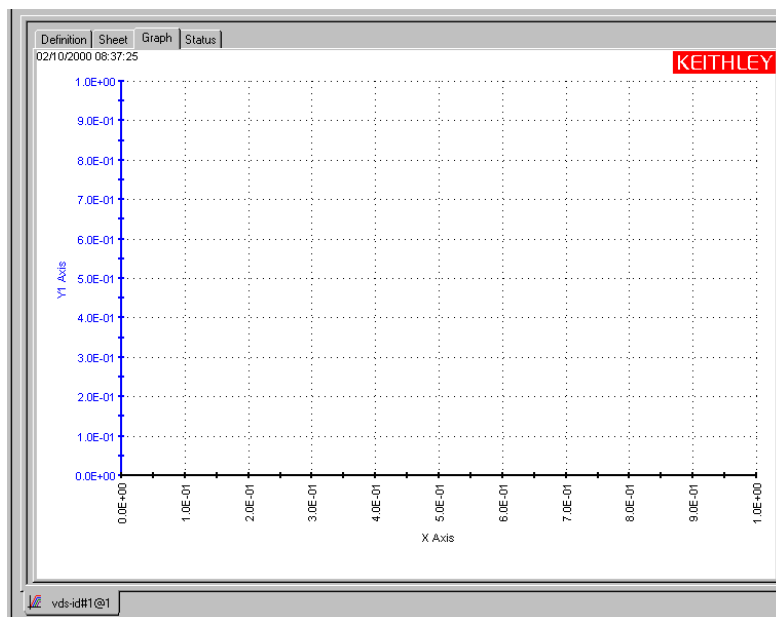
Opening a Graph tab

Open a **Graph** tab as follows:

1. Open the ITM or UTM window for the selected test by double-clicking on the test in the Project Navigator.
2. When the ITM or UTM window opens, click on the displayed **Graph**-tab label. The **Graph** tab opens.

[Figure 3-4](#) displays an unconfigured graph for the “vds-id” ITM. The time and date at which the data was generated are displayed in the upper left corner. However, the axes are labeled and scaled generically, because no project data has yet been assigned to the axes.

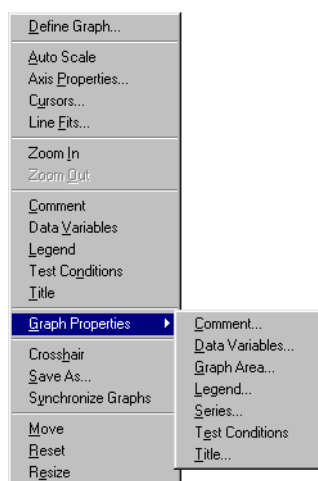
Figure 3-4
Example of an unconfigured graph tab



Reviewing the Graph Setting menu

Figure 3-5 below shows a larger view of the **Graph Setting** pop-up menu, including its **Graph Properties** submenu.

Figure 3-5
Graph settings menu



Graph Setting menu items are summarized below (Reference Manual notes refer to Section 6):

- **Define Graph** — Defines the parameters to be graphed and the axes on which these parameters are to be graphed. (Reference Manual discussion: “Defining the data to be graphed.”)
- **Auto Scale** — Automatically scales all axes only once, at a chosen point in time. (Reference Manual discussion: “Automatically scaling the axes.”)

- **Axis Properties** — Opens the Axes Properties window, which is the main access point for graph scaling and scale formatting. (Reference Manual discussion: “Defining the axis properties of the graph.”)
- **Cursors** — Opens the Cursors window, from which you can select and format cursors that display the precise numerical coordinates of specific points on the plot lines. (Reference Manual discussion: “Numerically displaying plot coordinates using cursors.”)
- **Line Fits** — Allows you to directly fit lines to **Graph** tab plots. Up to two fits may be performed on a graph, selected from among the following types: **Linear** (line through two data points), **Regression** (regression line), **Exponential**, **Logarithmic**, and **Tangent**.
- **Zoom In** — Allows you to enlarge and examine a small, selected part of the graph. (Reference Manual discussion: “Temporarily enlarging a selected area of the graph by zooming.”)
- **Zoom Out** — Restores a graph to the original or previously zoomed size. (Reference Manual discussion: “Temporarily enlarging a selected area of the graph by zooming.”)
- **Comment** — Opens the Comment window, which allows you to add and format a comment. (Reference Manual discussion: “Adding a comment.”)
- **Data Variables** — Opens the Data Variables window, from which you can configure the display of up to four data variables, along with the corresponding names (data variables being defined as extracted parameters or other values from the second row of a **Data** or **Calc** worksheet). The **Data Variables** menu item also toggles the data-variable display. (Reference Manual discussion: “Numerically displaying extracted parameters and other data variables.”)
- **Legend** — Toggles the display of an automatically created legend on and off. (Reference Manual discussion: “Adding a legend.”)
- **Test Conditions** — Displays the primary test conditions used to obtain the data in the graph. (Reference Manual discussion: “Displaying test conditions.”)
- **Title** — Opens the Title window, which allows you to add and format a title. (Reference Manual discussion: “Adding a title,” page 6-257.”)
- **Graph Properties**
 - **Comment** — Opens the Comment window, which allows you to add and format a comment. Same function as **Comment** in the main menu.
 - **Data Variables** — Opens the Data Variables window, from which you can configure the display of up to four data variables, along with the corresponding names (data variables being defined as extracted parameters or other values from the second row of a **Data** or **Calc** worksheet).
 - **Graph Area** — Opens the Graph Area menu, which allows you to change the graph foreground and background colors, toggle the time and date display, and make the graph 100% monochrome. (Reference Manual discussion: “Changing area properties of the graph.”)
 - **Legend** — Opens the Legend Properties window, which allows you to reformat the font, text or background color, or border of the legend. (Reference Manual discussion: “Adding a legend.”)
 - **Series** — Opens the Data Series Properties window, from which you can define color, line pattern, plot symbol, and line width for each plot. (Reference Manual discussion: “Defining the plot properties of the graph: colors, line patterns, symbols, line widths.”)
 - **Test Conditions** — Displays the primary test conditions used to obtain the data in the graph. (Reference Manual discussion: “Displaying test conditions.”)
 - **Title** — Opens the Title window, which allows you to add and format a title. Same function as **Title** in the main menu.
- **Crosshair** — Toggles the display of a set of cross hairs that can be positioned anywhere on the graph. (Reference Manual discussion: “Visually reading plot coordinates using cross hairs.”)

- **Save As** — Opens the Save As window, which allows you to save a graph in bitmap (.bmp) format for use elsewhere, such as in a report. (Reference Manual discussion: “Saving a graph as a bitmap file.”)
- **Synchronize Graphs** — For use when the presently open graph is only one of several graphs for the same test, each graph representing the data for a different site. In that case, **Synchronize Graphs** identically configures the graphs for all sites, automatically, using the presently open graph as the master. (Reference Manual discussion: “Identically configuring the graphs resulting from one test executed at multiple sites.”)
- **Move** — Toggles between a normal cursor and a crossed-arrow cursor. Moving the crossed-arrow cursor moves the graph, allowing you to relocate it on the **Graph** tab. (Reference Manual discussion: “Changing the position of a graph.”)
- **Reset** — Causes colors, graph size, and graph position to be restored to the defaults. (Reference Manual discussion: “Resetting certain graph properties to KITE defaults.”)
- **Resize** — Toggles between a normal cursor and a ruler cursor. Moving the ruler cursor expands or contracts the size of the graph. The new size is saved when the graph is saved. (By contrast, **Zoom In** affects only the *view* size, which cannot be saved.) Reference Manual discussion: “Changing the size of a graph.”

For details and example graphs for all **Graph Setting** menu items, see the specific subsections referenced above. (Find them in Section 6 of the Reference Manual under “Viewing data using the Graph tab.”) The next subsection describes the minimal setup required to define a graph.

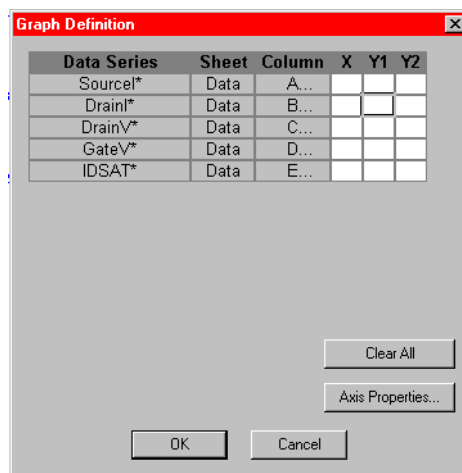
Defining a basic graph

Do the following

1. In the **Graph** tab, display the **Graph Settings** menu by right-clicking on the graph or by selecting **Tools** → **Graph Settings**.
2. In the **Graph Settings** menu, select **Define Graph**. The Graph Definition window opens. [Figure 3-6](#) shows the unconfigured Graph Definition window for a “vds-id” ITM. This example shows the usual “vds-id” parameters, plus two additional parameters.

Figure 3-6

Unconfigured Graph Definition window for a “vds-id” ITM

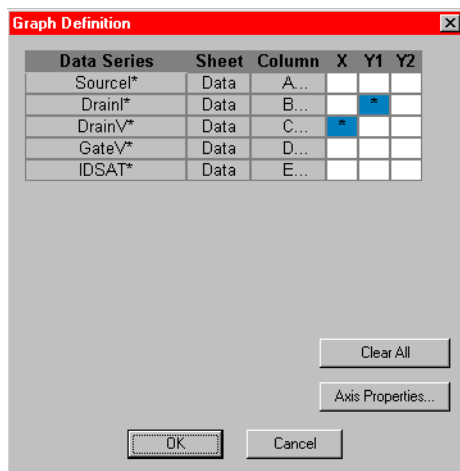


3. Using the Graph Definition window, indicate which parameters are to be plotted and assign them to appropriate axes by selecting the appropriate **X**, **Y1**, and **Y2** cells, where
 - **X** is the X axis.

- **Y1** is the Y axis on the left side of the graph.
- **Y2** is the Y axis on the right side of the graph.

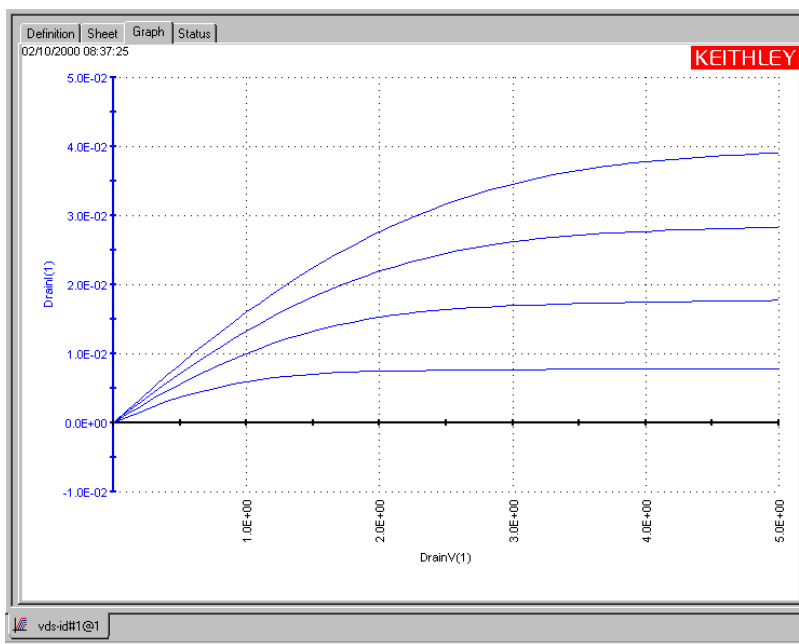
Figure 3-7 shows the same Graph Definition window as Figure 3-6 after cells are selected for the “vds-id” ITM parameters.

Figure 3-7
Configured Graph Definition window for the “vds-id” ITM



4. Click **OK**. The graph now displays basic plots of the selected parameters. In Figure 3-8, the “vds-id” graph now displays scaled axes and a series of four plots, reflecting Figure 3-7 selections. The curves are for four drain-voltage sweeps at different gate voltages.

Figure 3-8
“vds-id” graph after configuring its Graph Definition window



The axis labels are not yet optimally named. *KITE* inserted the default **Data** sheet column labels for sweep #1 of the data series. However, axis labels can be renamed. Refer in [Section 6 of the Reference Manual](#) to “Defining the axis properties of the graph.”

4

Protecting user files and system software

The Model 4200-SCS is built on a PC architecture, using the Microsoft® Windows® operating system. It includes a motherboard containing the main processor and RAM, a physical hard drive, a compact disk (CD) drive, a floppy disk drive, and other typical PC hardware elements. This architecture provides many advantages, including ease of use, built-in Windows tools and utilities, and extensive local file-storage space. However, PC architecture calls for PC precautions. This section describes recommendations for software and data preservation. The recommendations apply to any 4200-SCS unit that meets the following criteria:

- Was produced before or during Spring, 2003.
- Runs Windows XP Professional.
- Runs KTE Interactive software up to and including version 4.3.2.

Protecting software integrity

The Model 4200-SCS has been designed and thoroughly tested for maximum system stability, reliability, and performance *in the factory-standard configuration*. To protect the system software, observe the following tips:

- In Chapter 10 of the Reference Manual, review the “Approved third party software,” page 10-14, which lists software that a qualified system administrator may install on the 4200-SCS without affecting warranty coverage. If you absolutely must use software that is not on this list, exercise caution and common sense. Untested/unapproved software installed on the system hard drive may compromise system stability.
- Protect the system from viruses, which can reach the system via the facility network. (Note that Norton Antivirus is one of the Keithley-approved programs.)
- Certain software tools that come standard with the 4200-SCS, such as FAZAM (Full Armor Zero Administration) and Diskeeper, can help preserve software integrity. Be sure to use these tools — after properly configuring them.
- Do not attempt to format the system hard drive or reinstall the operating system. Though you may be able to successfully uninstall and reinstall some types of software on the 4200-SCS, you *cannot* successfully reformat the hard drive or reinstall the operating system. Attempting to do so will make the system inoperative and require factory repair.

CAUTION DO NOT reinstall or upgrade the Windows operating system (OS) on any Model 4200-SCS. This action should only be performed at an authorized Keithley service facility. Violation of this precaution will void the Model 4200-SCS warranty and may render the Model 4200-SCS unusable. Any attempt to reinstall or upgrade the Windows operating system will require a return-to-factory repair and will be treated as an out-of-warranty service, including time and material charges.

Protecting user file integrity

There is a small but finite risk that the hard drive will fail sometime during the useful life of the 4200-SCS, regardless of how well it has been cared for. Therefore, Keithley recommends backup — periodically saving the latest copy of the data on an external storage device — as the best way to preserve user application files and measurement data.

Choosing the files to be backed up

Keithley recommends backing up the following files and directories, where applicable:

- **The default user directory**

When a Model 4200-SCS is received from the factory, the C:\S4200\kiuser directory contains all installed test results and user application files — KITE projects, device libraries, test libraries, and KULT libraries. Subsequently, the 4200-SCS stores user-created data and application files in this same directory by default. Therefore, unless a system user or administrator has created new, independent user directories, you need only to back up C:\S4200\kiuser directory to preserve all test results and user application files.

NOTE *Avoid selective backups of C:\...\data subfolders, such as C:\S4200\kiuser\Projects\default\tests\data. Such backups do not preserve the additional application files that are needed to restore the associated test setups/conditions.*

- **Independent user directories**

If a system user or administrator has created new, independent user directories, back up those directories as well. C:\S4200\Johns_tests and C:\S4200\Janes_tests are examples of such directories.

- **Special data files and directories**

Finally, back up any additional, specialized data files or directories, such as the following:

- A file into which a User Test Module (UTM) automatically places test results. For example, a UTM could be programmed to put results into C:\TestData\test001.dat.
- A file that results from manual processing of data using Microsoft Excel.

NOTE *It is possible to back up virtually the whole hard drive¹. However, the 4200-SCS system files and application program files will occupy a large portion of the storage and may not be properly recoverable unless backed up using special software¹. Such backups may be justifiable only if the user directory structure is too complex for selective backup and when storage space is plentiful.*

Choosing the method of backup

A variety of internal and external storage options exist for backing up data (a detailed discussion of which exceeds the scope of this subsection). In all cases, needed storage capacity is the primary selection criterion, followed perhaps by media cost, read/write speed, and specific data accessibility. Table 4-1 lists some of the more popular options for the 4200-SCS.

Table 4-1
Common backup storage options for the 4200-SCS

Size of file/folder to be backed up ¹	Appropriate backup storage device	Storage medium
<1.44MB	The internal floppy (diskette) drive in the 4200-SCS	3.5" high-density floppy disks (diskettes)
<100MB	External parallel-port Zip drive, 100MB	100MB Zip disks
<250MB	External parallel-port Zip drive, 250MB	100MB or 250MB Zip disks
<700MB	Internal CD-RW (compact disk read-write) drive, if available on your 4200-SCS unit	CD-R (one-time writable) or CD-RW (rewritable) compact disks

1. You cannot back up files in that are normally in use — for example, certain system files — without special backup software. Before considering use of such software, review the precautions in “Protecting software integrity.”

Table 4-1 (cont.)

Common backup storage options for the 4200-SCS

Size of file/folder to be backed up¹	Appropriate backup storage device	Storage medium
Up to several GB	External tape drive	Tape cartridge
	Network server	None, locally

¹Including the size of the file allocation table that must be placed on the media. Therefore, the useful file-storage capacity of a given type of storage medium is a bit less than the rated size.

Index

B

- Backup, user files [4-2](#)
- Boundaries, operating
 - Source-Measure Units (SMUs) and PreAmps [1-7](#)
- Building
 - A Project [2-6](#)
 - A user library [2-24](#)

C

- Cables
 - For source-measure connections, triaxial
 - PreAmp [1-7](#)
 - SMU [1-7](#)
 - For system component connections [1-9](#)
- Caution
 - Correct line voltage for system [1-12](#)
 - License agreement, response to [1-3](#)
 - Triax connectors, avoiding damage [1-8](#)
 - Ventilation for system [1-8](#)
- Configuration
 - 4200-SCS instruments [1-13](#)
 - Basic graph [3-7](#)
 - ITMs [2-14](#)
 - System [1-13](#)
 - UTMs [2-18](#)
- Configuration Navigator [1-14](#)
- Connections
 - Device
 - Basic device connections [1-10](#)
 - Details [1-11](#)
 - Power [1-12](#)
 - System components [1-9](#)
- Current
 - Boundaries, for source-measure hardware [1-6](#), [1-7](#)
 - Ranges, for source-measure hardware [1-5](#)
- Cycle Mode [2-31](#)

D

- Data
 - File location [3-2](#)
 - File naming [3-2](#)
 - Viewing graphically [3-4](#)
 - Viewing numerically [3-3](#)
- Defining a new project [2-6](#)
- Definition of terms, in 4200-SCS context
 - Device [2-2](#)
 - ITM (Interactive Test Module) [2-2](#)
 - Project [2-2](#)
 - Site [2-2](#)
 - Subsite [2-2](#)
 - UTM (User Test Module) [2-2](#)
- Degradation targets [2-33](#), [2-34](#)
- Device
 - Connections
 - Basic device connections [1-10](#)
 - Details [1-11](#)
 - Definition, in 4200-SCS context [2-2](#)
- Device Plan
 - Inserting into a Project [2-8](#)

E

- Environment, installation [1-8](#)
- Execution, of tests [2-25](#)

F

- Features
 - Hardware [1-4](#)
 - Software [1-3](#)
- Files
 - Data files
 - Backup [4-2](#)
 - Location [3-2](#)
 - Naming [3-2](#)
 - Protecting integrity of
 - Software files [4-2](#)
 - User application and data files [4-2](#)

- Forcing function
 - Configuration of [2-15](#)
 - Types summary [2-13](#)
- Formulator
 - Where to find details about [2-16](#)
- Frequency, line power
 - Acceptable frequencies [1-12](#)
 - Where to configure system for [1-13](#)

G

- Graph tab
 - Opening the Graph tab [3-4](#)
 - Settings menu, item descriptions [3-5](#)
- Graph, basic, creating [3-4](#)
- Ground Unit (GNDU)
 - Overview [1-5](#)
 - Signals and limits at connectors [1-6](#)

H

- Hardware
 - Connecting devices to be tested [1-10](#)
 - Connecting power to, 4200-SCS [1-12](#)
 - Connecting system components [1-9](#)
 - Features and capabilities [1-4](#)
 - Required environment [1-8](#)

I

- Inserting into Project
 - Device Plan [2-8](#)
 - ITM [2-8](#)
 - Subsite Plan [2-7](#)
 - UTM [2-10](#)
- Installation
 - Connections. power [1-12](#)
 - Environment [1-8](#)
 - Inspecting the system [1-2](#)
 - Unpacking the system [1-2](#)
- Instrument panel features [1-4](#)
- Instruments, configuration
 - External instruments [1-13](#)
 - Internal instruments [1-13](#)
- ITM (Interactive Test Module)
 - Definition (configuration) [2-12](#)
 - Definition of term [2-2](#)
 - Execution [2-25](#)
 - In the Project Navigator [2-5](#)
 - Inserting into Project [2-8](#)

K

- KCON (Keithley CONfiguration utility)
 - Brief description [1-3](#)
 - Configuration Navigator [1-14](#)
 - Features overview [1-14](#)
 - Introduction [1-13](#)
 - Menu item descriptions [1-14](#)
- KITE (Keithley Interactive Test Environment)
 - Brief description [1-3](#)
 - Building a project
 - Defining the new project [2-6](#)
 - Inserting Device Plans [2-8](#)
 - Inserting the ITMs [2-8](#)
 - Inserting the Subsite Plans [2-7](#)
 - Inserting the UTMs [2-10](#)
 - Saving the project [2-11](#)
 - Configuring the Project ITMs
 - Connections, matching physical and virtual [2-14](#)
 - Forcing functions
 - configuring for each device terminal [2-15](#)
 - Formulator, setting up calculations [2-16](#)
 - Saving the ITM configuration [2-16](#)
 - Executing project tests
 - Executing *appended* tests and test sequences at single site [2-27](#)
 - Executing entire Project at multiple sites [2-28](#)
 - Executing entire Project at single site [2-27](#)
 - Executing single test at single site [2-25](#)
 - Executing single test *sequence* at single site [2-26](#)
- Interface
 - Overview [2-2](#)
 - Project Navigator [2-4](#)
- ITMs (Interactive Test Modules) and UTMs (User Test Modules) explained [2-5](#)
- Terminology definitions, test components
 - Device [2-2](#)
 - ITM [2-2](#)
 - Project [2-2](#)
 - Site [2-2](#)
 - Subsite [2-2](#)
 - Test [2-2](#)
 - UTM [2-2](#)
- Viewing test results graphically
 - Defining a basic graph [3-7](#)
 - Introduction [3-4](#)
 - Menu, Graph Setting [3-5](#)
 - Opening a Graph tab [3-4](#)
- Viewing test results numerically
 - Introduction [3-3](#)

KULT (Keithley User Library Tool)
Brief description [1-3](#)
Interface overview [2-20](#)
User library creation
Introduction [2-19](#)
Procedure [2-21](#)
User module creation
Checking the user module [2-25](#)
Introduction [2-19](#)
Procedure [2-21](#)
KXCI (Keithley External Control Interface)
Brief description [1-4](#)

L

License agreement, caution about negative response to [1-3](#)
Line power
Frequency, acceptable for system [1-12](#)
Voltage range, acceptable [1-12](#)
Line power receptacle, requirements [1-12](#)

M

Multi-site test sequence [2-28](#)

O

Operating boundaries
Source-Measure units (SMUs) and PreAmps [1-7](#)
Output Values [2-33](#)

P

Powering the system [1-12](#)
PreAmp
Overview [1-5](#)
Signal ranges and resolutions [1-5](#)
Signals and limits at connectors [1-6](#)
Preparing the system [1-1](#)
Project
Definition (configuration) of new [2-6](#)
Definition of term, in 4200-SCS context [2-2](#)
Executing tests in [2-25](#)
Inserting components [2-7](#)
Inserting Device Plan [2-8](#)
Inserting ITM [2-8](#)
Inserting Subsite Plan [2-7](#)
Inserting UTM [2-10](#)
Saving [2-11](#)
Project Navigator [2-4](#)
Explanation [2-4](#)
Using to access Project component configuration windows [2-11](#)
Using to build a Project [2-6](#)

Using to choose data to be displayed
Graphically [3-4](#)
Numerically [3-3](#)

Protection
Software integrity [4-2](#)
User file integrity [4-2](#)
Yourself, from shock, by proper instrument grounding [1-12](#)

R

Ranges, current and voltage
PreAmps [1-5](#)
Source-Measure units [1-5](#)
Repacking the system [1-2](#)
Repeating a test [2-30](#)

S

Safety
Protecting software integrity [4-2](#)
Protecting user file integrity [4-2](#)
When powering the system [1-12](#)
Sheet tab Data worksheet [3-3](#)
Signals
Limits
At source-measure hardware connectors [1-6](#)
Ranges and resolutions
PreAmp [1-5](#)
Source-Measure Unit (SMU) [1-5](#)
Types
At source-measure hardware connectors [1-6](#)
Site
Definition of term, in 4200-SCS [2-2](#)
Software
Features [1-3](#)
KXCI, brief description [1-4](#)
Protecting integrity of [4-2](#)
KCON
see KCON (Keithley CONFIGuration utility)
KITE
see KITE (Keithley Interactive Test Environment)
KULT (Keithley User Library Tool)
see KULT (Keithley User Library Tool)
Source-measure hardware
Connectors, signal types, and limits [1-6](#)
Source-Measure Unit (SMU)
Connections
To DUTs [1-10](#)
Triaxial cables for [1-7](#)
Overview [1-5](#)
Signal ranges and resolutions [1-5](#)
Signals and limits at connectors [1-6](#)
Stress/Measure Mode [2-31](#)

Subsite

Definition of term [2-2](#)

Subsite cycling [2-30](#)

Cycle Mode [2-31](#)

Cycle mode configuration [2-31](#)

Degradation targets [2-33](#), [2-34](#)

Output Values [2-33](#)

Start subsite cycling [2-31](#)

Stress/Measure Mode [2-31](#)

System

Configuration [1-13](#)

Hardware features [1-4](#)

Inspection [1-2](#)

Preparation [1-1](#)

Repacking for shipment [1-2](#)

Software features [1-3](#)

Understanding the system [1-1](#)

Unpacking the system [1-2](#)

T

Test

Data

Understanding [3-2](#)

Viewing graphically [3-4](#)

Viewing numerically [3-3](#)

Definition of term, in context of 4200-SCS [2-2](#)

Execution [2-25](#)

Insertion into project

ITM [2-8](#)

UTM [2-10](#)

Types, explained [2-5](#)

Triax connectors, avoiding damage [1-8](#)

U

User library

Creation of [2-19](#)

Definition of term [2-19](#)

Selection of for UTM [2-19](#)

User module

Creation of [2-19](#)

Definition of term [2-19](#)

Selection of for UTM [2-19](#)

UTM (User Test Module)

Defining

Configuration [2-18](#)

Creating custom user modules for [2-19](#)

Definition of term [2-2](#)

Execution [2-25](#)

In the Project Navigator [2-5](#)

Inserting into a Project [2-10](#)

V

Ventilation, system [1-8](#)

Viewing data

Graphically [3-4](#)

Numerically [3-3](#)

Voltage

Boundaries, for source-measure hardware [1-6](#), [1-7](#)

Line power

Acceptable range [1-12](#)

Caution [1-12](#)

Ranges, for source-measure hardware [1-5](#)

W

Warmup requirements for 4200-SCS [1-13](#)

Warning

Grounding requirement [1-12](#)

Line cord [1-12](#)

Power-up safety [1-2](#)

Specifications are subject to change without notice.

All Keithley trademarks and trade names are the property of Keithley Instruments, Inc.
All other trademarks and trade names are the property of their respective companies.

KEITHLEY

A GREATER MEASURE OF CONFIDENCE

Keithley Instruments, Inc.

Corporate Headquarters ¥ 28775 Aurora Road ¥ Cleveland, Ohio 44139 ¥ 440-248-0400 ¥ Fax: 440-248-6168 ¥ 1-888-KEITHLEY (534-8453) ¥ www.keithley.com

Belgium: Sint-Pieters-Leeuw ¥ 02-363 00 40 ¥ Fax: 02-363 00 64 ¥ www.keithley.nl

China: Beijing ¥ 8610-82251886 ¥ Fax: 8610-82251892 ¥ www.keithley.com.cn

Finland: Helsinki ¥ 09-5306-6560 ¥ Fax: 09-5306-6565 ¥ www.keithley.com

France: Palaiseau C dex ¥ 01-64 53 20 20 ¥ Fax: 01-60 11 77 26 ¥ www.keithley.fr

Germany: Germering ¥ 089/84 93 07-40 ¥ Fax: 089/84 93 07-34 ¥ www.keithley.de

Great Britain: Theale ¥ 0118 929 7500 ¥ Fax: 0118 929 7519 ¥ www.keithley.co.uk

India: Bangalore ¥ 080 212 8027 ¥ Fax : 080 212 8005 ¥ www.keithley.com

Italy: Milano ¥ 02-48 39 16 01 ¥ Fax: 02-48 30 22 74 ¥ www.keithley.it

Japan: Tokyo ¥ 81-3-5733-7555 ¥ Fax: 81-3-5733-7556 ¥ www.keithley.jp

Korea: Seoul ¥ 82-2-574-7778 ¥ Fax: 82-2-574-7838 ¥ www.keithley.com

Netherlands: Gorinchem ¥ 0183-635333 ¥ Fax: 0183-630821 ¥ www.keithley.nl

Singapore: Singapore ¥ 65-6747-9077 ¥ Fax: 65-6747-2991 ¥ www.keithley.com

Sweden: Solna ¥ 08-509 04 600 ¥ Fax: 08-655 26 10 ¥ www.keithley.com

Taiwan: Hsinchu ¥ 886-3-572-9077 ¥ Fax: 886-3-572-9031 ¥ www.keithley.com.tw